

ATHENA Za_WUa` fcdSuf

UN'ABITAZIONE RICAVATA DA UN AMBIENTE UNICO, Scopri sedie, poltrone, tavoli e complementi di design che si combinano con i mobili della tua sala da pranzo, soggiorno, cucina o terrazza. Trova l'opzione migliore per le tue stanze, scopri materiali, stili e colori esclusivi per differenziare la tua casa, trasformala in uno spazio comodo e piacevole per te e i tuoi ospiti. Sedie, tavoli e complementi di design ideale per la tua casa o il tuo spazio di lavoro, che si tratti di sedie in legno, sedie in plastica, metallo o sedie moderne a seconda del colore, come sedie gialle, sedie trasparenti, sedie nere, tra molte altre. Abbiamo anche sedie, poltrone, tavoli e complementi a seconda dello spazio in cui verranno collocate, dalle sedie da pranzo alle sedie da giardino. La nostra collezione offre una vasta gamma di mobili per soddisfare sia le impostazioni casual che quelle formali per la tua casa o lo spazio di lavoro.

A HOUSE OBTAINED FROM A UNIQUE ENVIRONMENT, Discover chairs, armchairs, tables and design accessories that combine with the furniture in your dining room, living room, kitchen or terrace. Find the best option for your rooms, discover exclusive materials, styles and colors to differentiate your home, transform it into a comfortable and pleasant space for you and your guests. Chairs, tables and design accessories ideal for your home or workspace, whether it's wooden chairs, plastic chairs, metal or modern chairs depending on the color, such as yellow chairs, transparent chairs, black chairs, among many others. We also have chairs, armchairs, tables and accessories depending on the space in which they will be placed, from dining chairs to garden chairs. Our collection offers a wide variety of furniture to suit both casual and formal settings for your home or workspace.



IMPILABILE. STACKABLE.



TAVOLO IMPILABILE. STACKABLE TABLE.



TAVOLO AFFIANCABILE. ADJUSTABLE TABLE.



TAVOLINO IMPILABILE. STACKABLE COFFEE TABLE.



LETTINO/SDRAIO IMPILABILE. STACKABLE COT/DECK CHAIR.



USO ESTERNO. EXTERNAL USE.



ATHENA dea dai mille volti... dea delle arti e dei mestieri, della battaglia e della strategia, nonchè della sapienza.
Goddess ATHENA of a thousand faces... goddess of arts and crafts, of battle and strategy, as well as of wisdom

POLIPROPILENE
SEDIE, POLTRONE E SGABELI IN POLIPROPILENE
pag. 03



IMBOTTITI
SEDIE, POLTRONE E SGABELI IMBOTTITI
pag. 45

LEGNO
SEDIE, POLTRONE E SGABELI IN LEGNO
pag. 71



METALLO
SEDIE, POLTRONE E SGABELI IN METALLO
pag. 79

TAVOLI
TAVOLI E TAVOLINI E SGABELLI
pag. 91

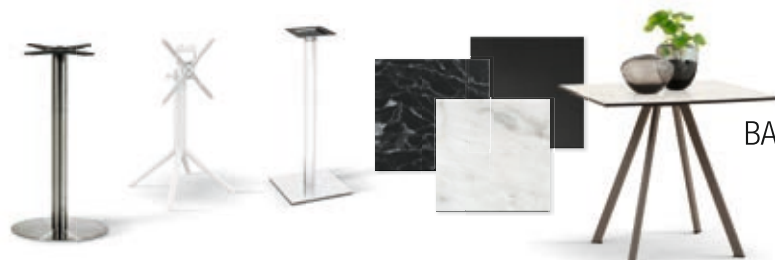

CONTRACT
BASAMENTI E PIANI PER TAVOLINI
pag. 109

RELAX
POLTRONE, POUF E DIVANETTI IMBOTTITI
pag. 121



COMPLEMENTI
TAVOLINI, CONSOLLE, MADIE, LAMPADE
E PORTA TV pag. 131



OUTDOORS
SALOTTI DA ESTERNO, OMBRELLONI E SDRAI
pag. 149



INDICE
INDICE ALFANUMERICO
pag. 163

POLIPROPILENE

UN'ABITAZIONE RICAVATA DA UN AMBIENTE UNICO, Scopri sedie, poltrone, tavoli e complementi di design che si combinano con i mobili della tua sala da pranzo, soggiorno, cucina o terrazza. Trova l'opzione migliore per le tue stanze, scopri materiali, stili e colori esclusivi per differenziare la tua casa, trasformala in uno spazio comodo e piacevole per te e i tuoi ospiti. Sedie, tavoli e complementi di design ideale per la tua casa o il tuo spazio di lavoro, che si tratti di sedie in legno, sedie in plastica, metallo o sedie moderne a seconda del colore, come sedie gialle, sedie trasparenti, sedie nere, tra molte altre. Abbiamo anche sedie, poltrone, tavoli e complementi a seconda dello spazio in cui verranno collocate, dalle sedie da pranzo alle sedie da giardino. La nostra collezione offre una vasta gamma di mobili per soddisfare sia le impostazioni casual che quelle formali per la tua casa o lo spazio di lavoro.

A HOUSE OBTAINED FROM A UNIQUE ENVIRONMENT, Discover chairs, armchairs, tables and design accessories that combine with the furniture in your dining room, living room, kitchen or terrace. Find the best option for your rooms, discover exclusive materials, styles and colors to differentiate your home, transform it into a comfortable and pleasant space for you and your guests. Chairs, tables and design accessories ideal for your home or workspace, whether it's wooden chairs, plastic chairs, metal or modern chairs depending on the color, such as yellow chairs, transparent chairs, black chairs, among many others. We also have chairs, armchairs, tables and accessories depending on the space in which they will be placed, from dining chairs to garden chairs. Our collection offers a wide variety of furniture to suit both casual and formal settings for your home or workspace.





COLORI. COLOURS.



Tortora.
Taupe.



Verde oliva.
Olive green.



Antracite.
Anthracite.

**Articolo LF6055**

Poltrona in polipropilene
con fibra di vetro colore tortora.
Polypropylene armchair
with fiber of glass taupe color.
cm. L. 58 P. 58 H. 80 H.S. 48

**Articolo LF6056**

Poltrona in polipropilene
con fibra di vetro colore antracite.
Polypropylene armchair
with fiber of glass anthracite color.
cm. L. 58 P. 58 H. 80 H.S. 48

**Articolo LF6057**

Poltrona in polipropilene
con fibra di vetro colore verde oliva.
Polypropylene armchair
with fiber of glass olive green color.
cm. L. 58 P. 58 H. 80 H.S. 48



COLORI. COLOURS.



Verde oliva.
Olive green.



Rosso mattone.
Brick red.



Tortora.
Taupe.



Antracite.
Anthracite.

**Articolo LF6178**

Sedia in polipropilene
con fibra di vetro colore verde oliva.
Polypropylene chair
with fiber of glass olive green color.
cm. L. 50 P. 59 H. 84 H.S. 47

**Articolo LF6179**

Sedia in polipropilene
con fibra di vetro colore rosso mattone.
Polypropylene chair
with fiber of glass brick red colour.
cm. L. 50 P. 59 H. 84 H.S. 47

**Articolo LF6180**

Sedia in polipropilene
con fibra di vetro colore tortora.
Polypropylene chair
with fiber of glass taupe colour.
cm. L. 50 P. 59 H. 84 H.S. 47

**Articolo LF6181**

Sedia in polipropilene
con fibra di vetro colore antracite.
Polypropylene chair
with fiber of glass anthracite colour.
cm. L. 50 P. 59 H. 84 H.S. 47

**Articolo LF6186**

Poltrona in polipropilene con fibra
di vetro colore antracite.
Polypropylene armchair with fiber
of glass anthracite colour.
cm. L. 58 P. 59 H. 84 H.S. 47



Articolo LF6176
 Sgabello in polipropilene
 con fibra di vetro colore tortora.
 Stool in polypropylene
 with glass fiber taupe colour.
 cm. L. 53 P. 55 H. 95 H.S. 65



Articolo LF6177
 Sgabello in polipropilene
 con fibra di vetro colore antracite.
 Stool in polypropylene
 with glass fiber anthracite colour.
 cm. L. 53 P. 55 H. 95 H.S. 65



Articolo LF6174
 Sgabello in polipropilene
 con fibra di vetro colore tortora.
 Stool in polypropylene
 with glass fiber taupe colour.
 cm. L. 53 P. 55 H. 105 H.S. 75



Articolo LF6175
 Sgabello in polipropilene
 con fibra di vetro colore antracite.
 Stool in polypropylene
 with glass fiber anthracite colour.
 cm. L. 53 P. 55 H. 105 H.S. 75



Articolo LF6184
 Poltrona in polipropilene
 con fibra di vetro colore rosso mattone.
 Polypropylene armchair
 with fiber of glass brick red colour.
 cm. L. 58 P. 59 H. 84 H.S. 47



Articolo LF6183
 Poltrona in polipropilene
 con fibra di vetro colore verde oliva.
 Polypropylene armchair
 with fiber of glass olive green colour.
 cm. L. 58 P. 59 H. 84 H.S. 47



Articolo LF6185
 Poltrona in polipropilene
 con fibra di vetro colore tortora.
 Polypropylene armchair
 with fiber of glass taupe colour.
 cm. L. 58 P. 59 H. 84 H.S. 47

SEDIA PER USO INTERNO ED ESTERNO

Stile ed originalità caratterizzano questa sedia, essa è il connubio tra passato e presente.
Grazie alla moderna tecnologia del polipropilene, diventa una creativa reinterpretazione delle classiche sedie in legno.
Grazie alla sua versatilità è adatta ad ambienti esterni ed interni.

CHAIR FOR INDOOR AND OUTDOOR USE

Style and originality characterize this chair, it is the combination of the past is present.
Thanks to modern polypropylene technology, she becomes creative reinterpretation of the classic wooden chairs.
Thanks to its versatility it is suitable for outdoor and indoor environments.

COLORI. COLOURS.

Antracite.
Anthracite.



Tortora.
Taupe.

**Articolo LF6080**

Sedia in polipropilene
con fibra di vetro colore antracite.
Polypropylene chair
with fiber of glass anthracite color.
cm. L. 51 P. 51 H. 87 H.S. 44

**Articolo LF6081**

Sedia in polipropilene
con fibra di vetro colore tortora.
Polypropylene chair
with fiber of glass taupe color.
cm. L. 51 P. 51 H. 87 H.S. 44



Articolo LF6085
Sgabello in polipropilene
con fibra di vetro colore antracite.
Polypropylene stool
with fiber of glass anthracite color.
cm. L. 45 P. 52 H. 106 H.S. 75



Articolo LF6086
Sgabello in polipropilene
con fibra di vetro colore tortora.
Polypropylene stool
with fiber of glass taupe color.
cm. L. 45 P. 52 H. 106 H.S. 75



Articolo LF6087
Sgabello in polipropilene
con fibra di vetro colore antracite.
Polypropylene stool
with fiber of glass anthracite color.
cm. L. 45 P. 52 H. 96 H.S. 65



Articolo LF6088
Sgabello in polipropilene
con fibra di vetro colore tortora.
Polypropylene stool
with fiber of glass taupe color.
cm. L. 45 P. 52 H. 96 H.S. 65

COLORI. COLOURS.



Antracite.
Anthracite.



Tortora.
Taupe.



Articolo LF6083
Poltrona in polipropilene
con fibra di vetro colore antracite.
Polypropylene armchair
with fiber of glass anthracite colour.
cm. L. 57 P. 52 H. 85 H.S. 44



Articolo LF6084
Poltrona in polipropilene
con fibra di vetro colore tortora.
Polypropylene armchair
with fiber of glass taupe colour.
cm. L. 57 P. 52 H. 85 H.S. 44

COLORI. COLOURS.



Antracite.
Anthracite.



Tortora.
Taupe.



Articolo LF6140
Sedia in polipropilene
con fibra di vetro colore tortora.
Polypropylene chair
with fiber of glass taupe colour.
cm. L. 45 P. 52 H. 85 H.S. 44



Articolo LF6141
Sedia in polipropilene
con fibra di vetro colore antracite.
Polypropylene chair
with fiber of glass anthracite colour.
cm. L. 45 P. 52 H. 85 H.S. 44



Articolo LF6145
Poltrona in polipropilene
con fibra di vetro colore tortora.
Polypropylene armchair
with fiber of glass taupe colour.
cm. L. 57 P. 52 H. 85 H.S. 44



Articolo LF6146
Poltrona in polipropilene
con fibra di vetro colore antracite.
Polypropylene armchair
with fiber of glass anthracite colour.
cm. L. 57 P. 52 H. 85 H.S. 44

COLORI. COLOURS.



Tortora.
Taupe.



Verde oliva.
Olive green.



Antracite.
Anthracite.



Articolo LF6165

Sedia pieghevole in polipropilene con fibra di vetro colore tortora.
Polypropylene folding chair with fiber of glass taupe colour.
cm. L. 42 P. 47 H. 83 H.S. 46



Articolo LF6166

Sedia pieghevole in polipropilene con fibra di vetro colore antracite.
Polypropylene folding chair with fiber of glass anthracite colour.
cm. L. 42 P. 47 H. 83 H.S. 46

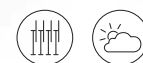

Articolo LF6167

Sedia pieghevole in polipropilene con fibra di vetro colore verde oliva.
Polypropylene folding chair with fiber of glass anthracite colour.
cm. L. 42 P. 47 H. 83 H.S. 46





Articolo LF6150
Sgabello in polipropilene
con fibra di vetro colore antracite.
Stool in polypropylene
with glass fiber anthracite color.
cm. L. 45 P. 51 H. 108 H.S. 75



Articolo LF6155
Sgabello in polipropilene
con fibra di vetro colore antracite.
Stool in polypropylene
with glass fiber anthracite color.
cm. L. 45 P. 51 H. 98 H.S. 65

COLORI. COLOURS.



Antracite.
Anthracite.



COLORI. COLOURS.



Bianco.
White.



Tortora.
Taupe.



Antracite.
Anthracite.



Nero.
Black.



Articolo LF6060
Sedia in polipropilene
con fibra di vetro colore bianco.
Polypropylene chair
with fiber of glass white color.
cm. L. 52 P. 56 H. 83 H.S. 46



Articolo LF6061
Sedia in polipropilene
con fibra di vetro colore tortora.
Polypropylene chair
with fiber of glass taupe color.
cm. L. 52 P. 56 H. 83 H.S. 46



Articolo LF6062
Sedia in polipropilene
con fibra di vetro colore antracite.
Polypropylene chair
with fiber of glass anthracite color.
cm. L. 52 P. 56 H. 83 H.S. 46



Articolo LF6063
Sedia in polipropilene
con fibra di vetro colore nero.
Polypropylene chair
with fiber of glass black color.
cm. L. 52 P. 56 H. 83 H.S. 46





Articolo LF6020
Sedia in polipropilene
con fibra di vetro colore bianco.
Polypropylene chair
with fiber of glass white color.
cm. L. 45 P. 53 H. 82 H.S. 45



Articolo LF6021
Sedia in polipropilene
con fibra di vetro colore tortora.
Polypropylene chair
with fiber of glass taupe color.
cm. L. 45 P. 53 H. 82 H.S. 45



COLORI. COLOURS.



Bianco.
White.



Tortora.
Taupe.



Antracite.
Anthracite.



Nero.
Black.



Articolo LF6022
Sedia in polipropilene
con fibra di vetro colore antracite.
Polypropylene chair
with fiber of glass anthracite color.
cm. L. 45 P. 53 H. 82 H.S. 45



Articolo LF6023
Sedia in polipropilene
con fibra di vetro colore nero.
Polypropylene chair
with fiber of glass black color.
cm. L. 45 P. 53 H. 82 H.S. 45

COLORI. COLOURS.



Bianco.
White.



Antracite.
Anthracite.



Tortora.
Taupe.

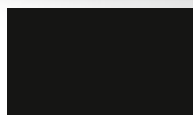

Nero.
Black.



Articolo LF6010
Poltrona in polipropilene
con fibra di vetro colore bianco.
Polypropylene armchair
with fiber of white color glass.
cm. L. 54 P. 53 H. 82 H.S. 45



Articolo LF6011
Poltrona in polipropilene
con fibra di vetro colore tortora.
Polypropylene armchair
with fiber of taupe color glass.
cm. L. 54 P. 53 H. 82 H.S. 45



Articolo LF6012
Poltrona in polipropilene
con fibra di vetro colore antracite.
Polypropylene armchair
with fiber of anthracite color glass.
cm. L. 54 P. 53 H. 82 H.S. 45



Articolo LF6013
Poltrona in polipropilene
con fibra di vetro colore nero.
Polypropylene armchair
with fiber of black color glass.
cm. L. 54 P. 53 H. 82 H.S. 45



COLORI. COLOURS.



Antracite.
Anthracite.



Tortora.
Taupe.



Articolo LF6190
Sgabello in polipropilene
con fibra di vetro colore tortora.
Stool in polypropylene
with glass fiber taupe color.
cm. L. 36 P. 36 H. 75



Articolo LF6191
Sgabello in polipropilene
con fibra di vetro colore antracite.
Stool in polypropylene
with glass fiber anthracite color.
cm. L. 36 P. 36 H. 75



Articolo LF6195
Sgabello in polipropilene
con fibra di vetro colore tortora.
Stool in polypropylene
with glass fiber taupe color.
cm. L. 36 P. 36 H. 65



Articolo LF6196
Sgabello in polipropilene
con fibra di vetro colore antracite.
Stool in polypropylene
with glass fiber anthracite color.
cm. L. 36 P. 36 H. 65

COLORI. COLOURS.



Tortora.
Taupe.



Antracite.
Anthracite.



Articolo LF6030

Poltrona in polipropilene
con fibra di vetro colore tortora.
Polypropylene armchair
with fiber of glass taupe color.
cm. L. 54 P. 53 H. 82 H.S. 45



Articolo LF6031

Poltrona in polipropilene
con fibra di vetro colore antracite.
Polypropylene armchair
with fiber of glass anthracite color.
cm. L. 54 P. 53 H. 82 H.S. 45



Articolo LF6040

Sedia in polipropilene
con fibra di vetro colore tortora.
Polypropylene chair
with fiber of glass taupe color.
cm. L. 45 P. 53 H. 82 H.S. 45



Articolo LF6041

Sedia in polipropilene
con fibra di vetro colore antracite.
Polypropylene chair
with fiber of glass anthracite color.
cm. L. 54 P. 53 H. 82 H.S. 45

Articolo LF385

Sedia in polipropilene colore verde azzurro.
Polypropylene chair sky blue green color.
cm. L. 42 P. 46 H. 79 H.S. 47



Articolo LF386

Sedia in polipropilene colore beige.
Polypropylene chair beige color.
cm. L. 42 P. 46 H. 79 H.S. 47



COLORI. COLOURS.



Beige.
Beige.



Verde azzurro.
Sky blue green.



Terracotta.
Terracotta.



Grigio.
Gray.



Articolo LF387

Sedia in polipropilene colore grigio.
Polypropylene chair gray color.
cm. L. 42 P. 46 H. 79 H.S. 47



Articolo LF388

Sedia in polipropilene colore terracotta.
Polypropylene chair terracotta color.
cm. L. 42 P. 46 H. 79 H.S. 47

COLORI. COLOURS.



Beige.
Beige.



Verde.
Green.



Grigio.
Gray.



Articolo LF362

Sedia in polipropilene colore grigio.
Polypropylene chair gray color.
cm. L. 46 P. 50 H. 80 H.S. 46



Articolo LF361

Sedia in polipropilene colore beige.
Polypropylene chair beige color.
cm. L. 46 P. 50 H. 80 H.S. 46



Articolo LF360

Sedia in polipropilene colore verde.
Polypropylene chair green color.
cm. L. 46 P. 50 H. 80 H.S. 46

COLORI. COLOURS.



Tortora.
Taupe.



Antracite.
Anthracite.



Articolo LF6090
Sedia in polipropilene
con fibra di vetro colore antracite.
Polypropylene chair
with fiber of glass anthracite color.
cm. L. 45 P. 52 H. 85 H.S. 44



Articolo LF6091
Sedia in polipropilene
con fibra di vetro colore tortora.
Polypropylene chair
with fiber of glass taupe color.
cm. L. 45 P. 52 H. 85 H.S. 44

COLORI. COLOURS.



Bianco.
White.



Grigio.
Gray.



Articolo LF789
Sedia in polipropilene
con fibra di vetro colore grigio.
Polypropylene chair
with fiber of glass gray color.
cm. L. 47 P. 54 H. 84 H.S. 47



Articolo LF790
Sedia in polipropilene
con fibra di vetro colore bianco.
Polypropylene chair
with fiber of glass white color.
cm. L. 47 P. 54 H. 84 H.S. 47



Articolo LF795
Poltrona in polipropilene
con fibra di vetro colore bianco.
Polypropylene armchair
with fiber of glass white color.
cm. L. 47 P. 54 H. 84 H.S. 47



Articolo LF6050
Sedia in polipropilene
con fibra di vetro colore bianco.
Polypropylene chair
with glass fiber white color.
cm. L. 54 P. 56 H. 82 H.S. 45



Articolo LF6051
Sedia in polipropilene
con fibra di vetro colore tortora.
Polypropylene chair
with glass fiber taupe color.
cm. L. 54 P. 56 H. 82 H.S. 45



COLORI. COLOURS.



Bianco.
White.



Tortora.
Taupe.



Antracite.
Anthracite.



Nero.
Black.



Articolo LF6052
Sedia in polipropilene
con fibra di vetro colore antracite.
Polypropylene chair
with glass fiber anthracite color.
cm. L. 54 P. 56 H. 82 H.S. 45



Articolo LF6053
Sedia in polipropilene
con fibra di vetro colore nero.
Polypropylene chair
with glass fiber black color.
cm. L. 54 P. 56 H. 82 H.S. 45

COLORI. COLOURS.



Tortora.
Taupe.



Antracite.
Anthracite.



Articolo LF6610
Sedia in polipropilene
con fibra di vetro colore tortora.
Polypropylene chair
with fiber of glass taupe color.
cm. L. 46 P. 51 H. 82 H.S. 46



Articolo LF6611
Sedia in polipropilene
con fibra di vetro colore antracite.
Polypropylene chair
with fiber of glass anthracite color.
cm. L. 46 P. 51 H. 82 H.S. 46



Articolo LF6612
Poltrona in polipropilene
con fibra di vetro colore tortora.
Polypropylene armchair
with fiber of glass taupe color.
cm. L. 55 P. 51 H. 82 H.S. 46



Articolo LF6613
Poltrona in polipropilene
con fibra di vetro colore antracite.
Polypropylene armchair
with fiber of glass anthracite color.
cm. L. 55 P. 51 H. 82 H.S. 46

COLORI. COLOURS.



Tortora.
Taupe.

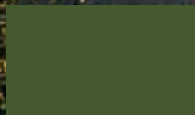

Verde.
Green.



Antracite.
Anthracite.



Articolo **LF6621**

Sedia in polipropilene
con fibra di vetro colore tortora.
Polypropylene chair
with glass fiber taupe color.
cm. L. 47 P. 56 H. 82 H.S. 42



Articolo **LF6623**

Sedia in polipropilene
con fibra di vetro colore verde.
Polypropylene chair
with glass fiber green color.
cm. L. 47 P. 56 H. 82 H.S. 42



Articolo **LF6622**

Sedia in polipropilene
con fibra di vetro colore antracite.
Polypropylene chair
with glass fiber anthracite color.
cm. L. 47 P. 56 H. 82 H.S. 42



Articolo LF6625

Poltrona in polipropilene
con fibra di vetro colore tortora.
Polypropylene armchair
with glass fiber taupe color.
cm. L. 56 P. 56 H. 82 H.S. 42

COLORI. COLOURS.



Tortora.
Taupe.



Verde.
Green.



Antracite.
Anthracite.



Articolo LF6626

Poltrona in polipropilene
con fibra di vetro colore antracite.
Polypropylene armchair
with glass fiber anthracite color.
cm. L. 56 P. 56 H. 82 H.S. 42



Articolo LF6627

Poltrona in polipropilene
con fibra di vetro colore verde.
Polypropylene armchair
with glass fiber green color.
cm. L. 56 P. 56 H. 82 H.S. 42



COLORI. COLOURS.



Tortora.
Taupe.



Antracite.
Anthracite.



Articolo LF6600
Sedia in polipropilene
con fibra di vetro colore tortora.
Polypropylene chair
with fiber of glass taupe color.
cm. L. 46 P. 51 H. 82 H.S. 46



Articolo LF6601
Sedia in polipropilene
con fibra di vetro colore antracite.
Polypropylene chair
with fiber of glass anthracite color.
cm. L. 54 P. 56 H. 82 H.S. 46



Articolo LF6605
Poltrona in polipropilene
con fibra di vetro colore tortora.
Polypropylene armchair
with fiber of glass taupe color.
cm. L. 55 P. 51 H. 82 H.S. 46



Articolo LF6606
Poltrona in polipropilene
con fibra di vetro colore antracite.
Polypropylene armchair
with fiber of glass anthracite color.
cm. L. 55 P. 51 H. 82 H.S. 46

**Articolo LF509**

Sedia in polipropilene colore grigio.
Polypropylene chair gray color.
cm. L. 46 P. 46 H. 78 H.S. 45

**Articolo LF502**

Sedia in polipropilene colore bianco.
Polypropylene chair white color.
cm. L. 46 P. 46 H. 78 H.S. 45

**Articolo LF503**

Sedia in polipropilene colore nero.
Polypropylene chair black color.
cm. L. 46 P. 46 H. 78 H.S. 45

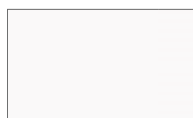
COLORI. COLOURS.

Bianco.
White.



Grigio.
Gray.



Nero.
Black.

**Articolo LF576**

Sedia in polipropilene colore nero.
Polypropylene chair black color.
cm. L. 46 P. 52 H. 80 H.S. 47

**Articolo LF577**

Sedia in polipropilene colore bianco.
Polypropylene chair white color.
cm. L. 46 P. 52 H. 80 H.S. 47

COLORI. COLOURS.

Bianco.
White.Terracotta.
Terracotta.Giallo.
Yellow.Rosso.
Red.Verde oliva.
Olive green.Grigio.
Gray.Nero.
Black.Arancio.
Orange.Beige.
Beige.**Articolo LF631**Sedia in polipropilene colore arancione.
Polypropylene chair orange color.
cm. L. 45 P. 53 H. 82 H.S. 45**Articolo LF630**Sedia in polipropilene colore giallo.
Polypropylene chair yellow color.
cm. L. 45 P. 53 H. 82 H.S. 45**Articolo LF384**Sedia in polipropilene colore verde oliva.
Polypropylene chair olive green color.
cm. L. 45 P. 53 H. 82 H.S. 45**Articolo LF383**Sedia in polipropilene colore terracotta.
Polypropylene chair terracotta color.
cm. L. 45 P. 53 H. 82 H.S. 45**Articolo LF632**Sedia in polipropilene colore rosso.
Polypropylene chair red color.
cm. L. 45 P. 53 H. 82 H.S. 45**Articolo LF382**Sedia in polipropilene colore grigio.
Polypropylene chair gray color.
cm. L. 45 P. 53 H. 82 H.S. 45**Articolo LF634**Sedia in polipropilene colore bianco.
Polypropylene chair white color.
cm. L. 45 P. 53 H. 82 H.S. 45**Articolo LF686**Sedia in polipropilene colore nero.
Polypropylene chair black color.
cm. L. 45 P. 53 H. 82 H.S. 45**Articolo LF381**Sedia in polipropilene colore beige.
Polypropylene chair beige color.
cm. L. 45 P. 53 H. 82 H.S. 45

COLORI. COLOURS.

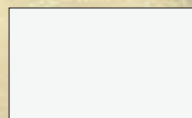

Bianco.
White.

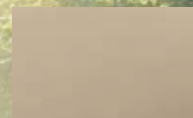

Beige.
Beige.

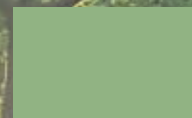

Verde.
Green.



Grigio.
Gray.



Articolo LF371
Sedia in polipropilene colore beige.
Polypropylene chair beige color.
cm. L. 46 P. 50 H. 80 H.S. 46



Articolo LF373
Sedia in polipropilene colore bianco.
Polypropylene chair white color.
cm. L. 46 P. 50 H. 80 H.S. 46



Articolo LF370
Sedia in polipropilene colore verde.
Polypropylene chair green color.
cm. L. 46 P. 50 H. 80 H.S. 46



Articolo LF372
Sedia in polipropilene colore grigio.
Polypropylene chair gray color.
cm. L. 46 P. 50 H. 80 H.S. 46



COLORI. COLOURS.



Bianco.
White.



Grigio.
Gray.



Nero.
Black.



Articolo LF773

Sgabello girevole up&down
in polipropilene colore bianco.
Polypropylene swivel up&down stool white color.
cm. L. 44 P. 46 H. 80/100 H.S. 58/78



Articolo LF769

Sgabello girevole up&down
in polipropilene colore nero.
Polypropylene swivel up&down stool black color.
cm. L. 44 P. 46 H. 80/100 H.S. 58/78



Articolo LF774

Sgabello girevole up&down
in polipropilene colore grigio.
Polypropylene swivel up&down stool gray color.
cm. L. 44 P. 46 H. 80/100 H.S. 58/78

COLORI. COLOURS.



Bianco.
White.



Grigio.
Gray.



Nero.
Black.



Articolo LF719

Sgabello girevole up&down in polipropilene bianco con fondino in similpelle bianco.
Swivel up&down stool in polypropylene white with white leatherette base.
cm. L. 44 P. 42 H. 80/100 H.S. 58/78



Articolo LF718

Sgabello girevole up&down in polipropilene nero con fondino in similpelle nero.
Swivel up&down stool in polypropylene black with black leatherette base.
cm. L. 44 P. 42 H. 80/100 H.S. 58/78



Articolo LF729

Sgabello girevole up&down in polipropilene grigio con fondino in similpelle grigio.
Swivel up&down stool in polypropylene gray with gray leatherette base.
cm. L. 44 P. 42 H. 80/100 H.S. 58/78

Articolo LF952

Sedia in polipropilene colore bianco, fondino similpelle nera con gambe legno.
Chair in white polypropylene, black leatherette seat with wooden legs.
cm. L. 47 P. 50 H. 79 H.S. 48

Articolo LF890

Sgabello in polipropilene colore bianco, fondino similpelle nera con gambe legno e metallo.
Stool in white polypropylene, black leatherette seat with wooden and metal legs.
cm. L. 47 P. 50 H. 107 H.S. 76



COLORI. COLOURS.



Bianco.
White.



Tortora.
Taupe.



Grigio.
Gray.



Nero.
Black.

Articolo LF392

Sedia in polipropilene colore grigio.
Polypropylene chair gray color.
cm. L. 45 P. 54 H. 80 H.S. 45

**Articolo LF393**

Sedia in polipropilene colore bianco.
Polypropylene chair white color.
cm. L. 45 P. 54 H. 80 H.S. 45

**Articolo LF390**

Sedia in polipropilene colore nero.
Polypropylene chair black color.
cm. L. 45 P. 54 H. 80 H.S. 45

**Articolo LF391**

Sedia in polipropilene colore beige.
Polypropylene chair beige color.
cm. L. 45 P. 54 H. 80 H.S. 45



COLORI. COLOURS.



Bianco.
White.

Rosso.
Red.

Giallo.
Yellow.

Verde.
Green.

Grigio.
Gray.

Nero.
Black.



Articolo LF591

Sedia in polipropilene colore rosso.
Polypropylene chair red color.
cm. L. 45 P. 54 H. 80 H.S. 45



Articolo LF590

Sedia in polipropilene colore bianco.
Polypropylene chair with color.
cm. L. 45 P. 54 H. 80 H.S. 45



Articolo LF925

Sedia in polipropilene colore nero.
Polypropylene chair black color.
cm. L. 45 P. 54 H. 80 H.S. 45



Articolo LF926

Sedia in polipropilene colore verde.
Polypropylene chair green color.
cm. L. 45 P. 54 H. 80 H.S. 45



Articolo LF592

Sedia in polipropilene colore giallo.
Polypropylene chair yellow color.
cm. L. 45 P. 54 H. 80 H.S. 45



Articolo LF928

Sedia in polipropilene colore grigio.
Polypropylene chair gray color.
cm. L. 45 P. 54 H. 80 H.S. 45

**Articolo LF482**

Sedia in polipropilene
colore giallo gambe legno e metallo.
Polypropylene chair
yellow color wood and metal legs.
cm. L. 47 P. 52 H. 84 H.S. 43

**Articolo LF483**

Sedia in polipropilene
colore azzurro gambe legno e metallo.
Polypropylene chair
sky blue color wood and metal legs.
cm. L. 47 P. 52 H. 84 H.S. 43

**Articolo LF484**

Sedia in polipropilene
colore arancio gambe legno e metallo.
Polypropylene chair
orange color wood and metal legs.
cm. L. 47 P. 52 H. 84 H.S. 43

**COLORI. COLOURS.**

Giallo.
Yellow.



Azzurro.
Sky blue.



Arancio.
Orange.



Articolo LF441
Poltroncina in polipropilene
colore bianco gambe legno e metallo.
Polypropylene armchair
white color wood and metal legs.
cm. L. 62 P. 62 H. 82 H.S. 43



Articolo LF457
Poltroncina in polipropilene
colore verde gambe legno e metallo.
Polypropylene armchair
green color wood and metal legs.
cm. L. 62 P. 62 H. 82 H.S. 43



Articolo LF458
Poltroncina in polipropilene
colore giallo gambe legno e metallo.
Polypropylene armchair
yellow color wood and metal legs.
cm. L. 62 P. 62 H. 82 H.S. 43



Articolo LF459
Poltroncina in polipropilene
colore azzurro gambe legno e metallo.
Polypropylene armchair
sky blue color wood and metal legs.
cm. L. 62 P. 62 H. 82 H.S. 43



Articolo LF460
Poltroncina in polipropilene
colore arancione gambe legno e metallo.
Polypropylene armchair
orange color wood and metal legs.
cm. L. 62 P. 62 H. 82 H.S. 43



Articolo LF461
Poltroncina in polipropilene
colore grigio gambe legno e metallo.
Polypropylene armchair
gray color wood and metal legs.
cm. L. 62 P. 62 H. 82 H.S. 43



POLIPROPILENE

COLORI. COLOURS.

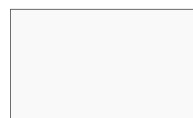

Bianco.
White.



Rosso.
Red.



Verde.
Green.



Giallo.
Yellow.



Azzurro.
Sky blue.



Arancio.
Orange.



Grigio.
Gray.



Articolo LF456
Poltroncina in polipropilene
colore rosso gambe legno e metallo.
Polypropylene armchair
red color wood and metal legs.
cm. L. 62 P. 62 H. 82 H.S. 43

COLORI. COLOURS.

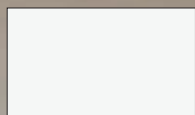

Bianco.
White.

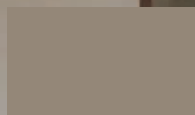

Tortora.
Taupe.

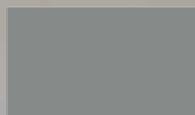

Grigio.
Gray.

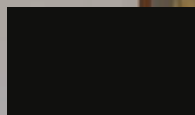

Nero.
Black.

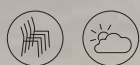
**Articolo LF7002**

Sedia in polipropilene
con fibra di vetro colore tortora.
Polypropylene chair
with fiber of glass taupe color.
cm. L. 46 P. 56 H. 82 H.S. 47

**Articolo LF7000**

Sedia in polipropilene
con fibra di vetro colore nero.
Polypropylene chair
with fiber of glass black color.
cm. L. 46 P. 56 H. 82 H.S. 47

**Articolo LF7001**

Sedia in polipropilene
con fibra di vetro colore grigio.
Polypropylene chair
with fiber of glass gray color.
cm. L. 46 P. 56 H. 82 H.S. 47

**Articolo LF7003**

Sedia in polipropilene
con fibra di vetro colore bianco.
Polypropylene chair
with fiber of glass white color.
cm. L. 46 P. 56 H. 82 H.S. 47



Articolo LF7012
 Poltrona in polipropilene
 con fibra di vetro colore tortora.
 Polypropylene armchair
 with fiber of glass taupe color.
 cm. L. 57 P. 56 H. 82 H.S. 47



Articolo LF7013
 Poltrona in polipropilene
 con fibra di vetro colore bianco.
 Polypropylene armchair
 with fiber of glass white color.
 cm. L. 57 P. 56 H. 82 H.S. 47



Articolo LF7010
 Poltrona in polipropilene
 con fibra di vetro colore nero.
 Polypropylene armchair
 with fiber of glass black color.
 cm. L. 57 P. 56 H. 82 H.S. 47



Articolo LF7011
 Poltrona in polipropilene
 con fibra di vetro colore grigio.
 Polypropylene armchair
 with fiber of glass gray color.
 cm. L. 57 P. 56 H. 82 H.S. 47





COLORI. COLOURS.



Rosa.
Pink.



Nero.
Black.



Articolo LF791

Sedia in polipropilene colore rosa.

Polypropylene chair pink color.

cm. L. 50 P. 57 H. 82 H.S. 46



Articolo LF787

Sedia in polipropilene colore nero.

Polypropylene chair black color.

cm. L. 42 P. 50 H. 80 H.S. 46

COLORI. COLOURS.



Bianco.
White.



Rosa.
Pink.



Beige.
Beige.



Giallo.
Yellow.



Nero.
Black.



Articolo LF779
Poltrona in polipropilene colore beige.
Polypropylene armchair beige color.
cm. L. 47 P. 54 H. 84 H.S. 47



Articolo LF782
Poltrona in polipropilene colore bianco.
Polypropylene armchair with color.
cm. L. 47 P. 54 H. 84 H.S. 47



Articolo LF781
Poltrona in polipropilene colore nero.
Polypropylene armchair black color.
cm. L. 47 P. 54 H. 84 H.S. 47



Articolo LF796
Poltrona in polipropilene colore giallo.
Polypropylene armchair yellow color.
cm. L. 57 P. 57 H. 82 H.S. 47



Articolo LF797
Poltrona in polipropilene colore rosa.
Polypropylene armchair pink color.
cm. L. 57 P. 57 H. 82 H.S. 47



Articolo LF642

Sedia in policarbonato trasparente.

Transparent polycarbonate chair.

cm. L. 45 P. 53 H. 90 H.S. 46

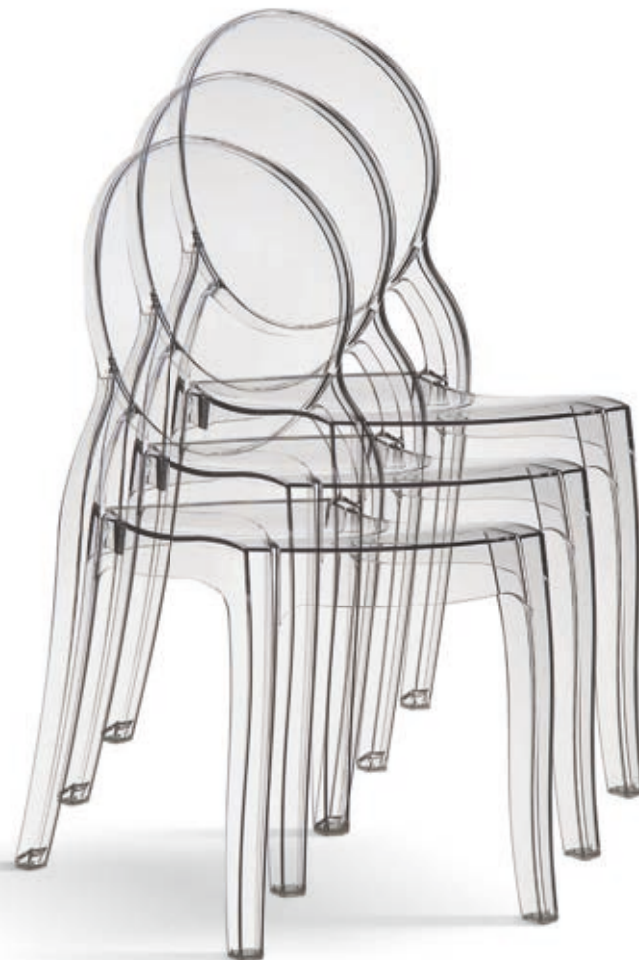

Articolo LF6070

Sedia in policarbonato trasparente con fibra di vetro.

Transparent polycarbonate chair with fiber of glass

cm. L. 47 P. 50 H. 90 H.S. 45



Articolo LF516
Sedia in polipropilene bianco lucido.
Glossy white polypropylene chair.
cm. L. 46 P. 54 H. 97 H.S. 47



Articolo LF517
Sedia in polipropilene nero lucido.
Glossy black polypropylene chair.
cm. L. 57 P. 54 H. 97 H.S. 47



Articolo LF625
Sedia in polipropilene trasparente.
Transparent polypropylene chair.
cm. L. 46 P. 54 H. 97 H.S. 47

COLORI. COLOURS.



Trasparente.
Transparent.



Trasparente fumè.
Smoked transparent.



Bianco.
White.



Nero.
Black.



Articolo LF627
Sedia in polipropilene trasparente fumè.
Smoked transparent polypropylene chair.
cm. L. 46 P. 54 H. 97 H.S. 47



Articolo LF626
Poltrona in polipropilene trasparente.
Transparent polypropylene armchair.
cm. L. 57 P. 54 H. 97 H.S. 47



Articolo LF628
Poltrona in polipropilene trasparente fumè.
Smoked transparent polypropylene armchair.
cm. L. 57 P. 54 H. 97 H.S. 47



COLORI. COLOURS.



Tortora.
Taupe.



Antracite.
Anthracite.



Articolo LF6121
Sedia in polipropilene con fibra di vetro colore antracite.
Polypropylene chair with fiber of glass anthracite color.
cm. L. 50 P. 60 H. 82 H.S. 44



Articolo LF6120
Sedia in polipropilene con fibra di vetro colore tortora.
Polypropylene chair with fiber of glass taupe color.
cm. L. 50 P. 60 H. 82 H.S. 44

COLORI. COLOURS.



Tortora.
Taupe.



Antracite.
Anthracite.

Articolo LF6126

Poltrona in polipropilene
con fibra di vetro colore antracite.
Polypropylene armchair
with fiber of glass anthracite color.
cm. L. 57 P. 60 H. 81 H.S. 44



Articolo LF6125

Poltrona in polipropilene
con fibra di vetro colore tortora.
Polypropylene armchair
with fiber of glass taupe color.
cm. L. 57 P. 60 H. 81 H.S. 44



Articolo LF6135

Sgabello in polipropilene
con fibra di vetro colore tortora.
Polypropylene stool
with fiber of glass taupe color.
cm. L. 44 P. 51 H. 95 H.S. 65



Articolo LF6136

Sgabello in polipropilene
con fibra di vetro colore antracite.
Polypropylene stool with fiber
of glass anthracite color.
cm. L. 44 P. 51 H. 95 H.S. 65



Articolo LF6130

Sgabello in polipropilene
con fibra di vetro colore tortora.
Polypropylene stool
with fiber of glass taupe color.
cm. L. 45 P. 53 H. 105 H.S. 75



Articolo LF6131

Sgabello in polipropilene
con fibra di vetro colore antracite.
Polypropylene stool
with fiber of glass anthracite color.
cm. L. 45 P. 53 H. 105 H.S. 75



Articolo LF770

Poltroncina in polipropilene colore grigio.
Polypropylene armchair gray color.
cm. L. 59 P. 55 H. 80 H.S. 46,5



Articolo LF6620

Poltrona in polipropilene con fibra di vetro colore antracite.
Polypropylene armchair with fiber of glass anthracite color.
cm. L. 57 P. 54 H. 85 H.S. 45



Articolo LF6615

Poltrona in polipropilene con fibra di vetro colore antracite.
Polypropylene armchair with fiber of glass anthracite color.
cm. L. 58 P. 54 H. 82 H.S. 45



Articolo LF639

Sedia in polipropilene colore bianco.
Polypropylene chair white color.
cm. L. 42 P. 50 H. 70 H.S. 46



Articolo LF6075

Sedia in polipropilene con fibra di vetro colore bianco.
Polypropylene chair with fiber of glass white color.
cm. L. 45 P. 55 H. 91 H.S. 46



Articolo LF673

Sedia in polipropilene trasparente.
Transparent polypropylene chair.
cm. L. 44 P. 52 H. 89 H.S. 44

COLORI. COLOURS.



Bianco.
White.



Trasparente.
Transparent.

COLORI. COLOURS.

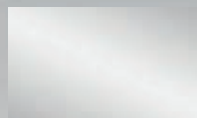

Trasparente.
Transparent.

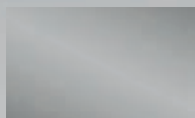

Trasparente fumè.
Smoked transparent.



Articolo LF942
Sedia in polipropilene trasparente fumè con schienale tipo paglia di Vienna.
Smoked transparent polypropylene chair with Vienna straw backrest.
cm. L. 46 P. 55 H. 88 H.S. 47



Articolo LF941
Sedia in polipropilene trasparente schienale tipo paglia di Vienna.
Transparent polypropylene chair with Vienna straw backrest.
cm. L. 46 P. 55 H. 88 H.S. 47



Articolo LF899
Sedia in polipropilene colore nero lucido.
Polypropylene chair glossy black colour.
cm. L. 46 P. 55 H. 88 H.S. 47



Articolo LF949
Sedia in polipropilene colore nero lucido con schienale tipo paglia di Vienna.
Polypropylene chair glossy black colour with Vienna straw backrest.
cm. L. 46 P. 55 H. 88 H.S. 47



Articolo LF938
Sedia in polipropilene colore bianco lucido schienale tipo paglia di Vienna.
Polypropylene chair glossy white colour Vienna straw backrest.
cm. L. 46 P. 55 H. 88 H.S. 47

COLORI. COLOURS.



Bianco lucido.
Glossy white.



Nero lucido.
Glossy black.



COLORI. COLOURS.



Tortora.
Taupe.



Antracite.
Anthracite.



Articolo LF6006

Poltrona in polipropilene con fibra di vetro colore antracite e tessuto textilene nero.
Polypropylene armchair with fiber of glass anthracite color and black textilene fabric.
cm. L. 57 P. 62 H. 90 H.S. 44



Articolo LF6005

Poltrona in polipropilene con fibra di vetro colore tortora e tessuto textilene beige.
Polypropylene armchair with fiber of glass taupe color and beige textilene fabric.
cm. L. 57 P. 62 H. 90 H.S. 44



Articolo LF5000

Sedia in polipropilene intreccio con fibra di vetro colore antracite.
Chair in woven polypropylene with fiber of glass anthracite color.
cm. L. 47 P. 59 H. 86 H.S. 47



Articolo LF5001

Poltrona in polipropilene intreccio con fibra di vetro colore antracite.
Armchair in woven polypropylene with fiber of glass anthracite color.
cm. L. 57 P. 59 H. 86 H.S. 47

IMBOTTITI

UN'ABITAZIONE RICAVATA DA UN AMBIENTE UNICO, Scopri sedie, poltrone, tavoli e complementi di design che si combinano con i mobili della tua sala da pranzo, soggiorno, cucina o terrazza. Trova l'opzione migliore per le tue stanze, scopri materiali, stili e colori esclusivi per differenziare la tua casa, trasformala in uno spazio comodo e piacevole per te e i tuoi ospiti. Sedie, tavoli e complementi di design ideale per la tua casa o il tuo spazio di lavoro, che si tratti di sedie in legno, sedie in plastica, metallo o sedie moderne a seconda del colore, come sedie gialle, sedie trasparenti, sedie nere, tra molte altre. Abbiamo anche sedie, poltrone, tavoli e complementi a seconda dello spazio in cui verranno collocate, dalle sedie da pranzo alle sedie da giardino. La nostra collezione offre una vasta gamma di mobili per soddisfare sia le impostazioni casual che quelle formali per la tua casa o lo spazio di lavoro.

A HOUSE OBTAINED FROM A UNIQUE ENVIRONMENT, Discover chairs, armchairs, tables and design accessories that combine with the furniture in your dining room, living room, kitchen or terrace. Find the best option for your rooms, discover exclusive materials, styles and colors to differentiate your home, transform it into a comfortable and pleasant space for you and your guests. Chairs, tables and design accessories ideal for your home or workspace, whether it's wooden chairs, plastic chairs, metal or modern chairs depending on the color, such as yellow chairs, transparent chairs, black chairs, among many others. We also have chairs, armchairs, tables and accessories depending on the space in which they will be placed, from dining chairs to garden chairs. Our collection offers a wide variety of furniture to suit both casual and formal settings for your home or workspace.





Articolo LF2196
Sedia con braccioli imbottita
in similpelle grigio gambe in metallo.
Chair with armrests upholstered
in gray leatherette metal legs.
cm. L. 58 P. 57 H. 81 H.S. 48



Articolo LF2190
Sedia con braccioli imbottita
in tessuto beige gambe in metallo.
Chair with armrests upholstered
in beige fabric metal legs.
cm. L. 58 P. 57 H. 81 H.S. 48



Articolo LF2191
Sedia con braccioli imbottita
in tessuto grigio gambe in metallo.
Chair with armrests upholstered
in gray fabric metal legs.
cm. L. 58 P. 57 H. 81 H.S. 48



Articolo LF2195
Sedia con braccioli imbottita
in similpelle marrone gambe in metallo.
Chair with armrests upholstered
in brown leatherette metal legs.
cm. L. 58 P. 57 H. 81 H.S. 48



Articolo LF2110
Sedia girevole imbottita in similpelle marrone gambe in metallo.
Upholstered swivel chair in brown leatherette metal legs.
cm. L. 50 P. 60 H. 83 H.S. 46



Articolo LF2120
Sedia girevole con braccioli imbottita in similpelle marrone gambe in metallo.
Swivel chair with armrests upholstered in brown leatherette metal legs.
cm. L. 56 P. 62 H. 83 H.S. 46



Articolo LF2111
Sedia girevole imbottita in similpelle grigio gambe in metallo.
Upholstered swivel chair in gray leatherette metal legs.
cm. L. 50 P. 60 H. 83 H.S. 46



Articolo LF2121
Sedia girevole con braccioli imbottita in similpelle grigio gambe in metallo.
Swivel chair with armrests upholstered in gray leatherette metal legs.
cm. L. 56 P. 62 H. 83 H.S. 46



Articolo LF2115
Sedia girevole imbottita in tessuto beige gambe in metallo.
Upholstered swivel chair in beige fabric metal legs.
cm. L. 50 P. 60 H. 83 H.S. 46



Articolo LF2125
Sedia girevole con braccioli imbottita in tessuto beige gambe in metallo.
Swivel chair with armrests upholstered in beige fabric metal leg.
cm. L. 56 P. 62 H. 83 H.S. 46



Articolo LF2116
Sedia girevole imbottita in tessuto grigio gambe in metallo.
Upholstered swivel chair in gray fabric metal legs.
cm. L. 50 P. 60 H. 83 H.S. 46



Articolo LF2126
Sedia girevole con braccioli imbottita in tessuto grigio gambe in metallo.
Swivel chair with armrests upholstered in gray fabric metal leg.
cm. L. 56 P. 62 H. 83 H.S. 46



Articolo LF2180

Sedia con braccioli imbottita in similpelle beige e tessuto grigio gambe in metallo.
Chair with armrests upholstered in beige leatherette and gray fabric metal legs.

cm. L. 61 P. 64 H. 86,5 H.S. 48



Articolo LF2181

Sedia con braccioli imbottita in similpelle beige e tessuto arancione gambe in metallo.
Chair with armrests upholstered in beige leatherette and orange fabric metal legs.

cm. L. 61 P. 64 H. 86,5 H.S. 48



Articolo LF2182

Sedia con braccioli imbottita in similpelle e tessuto grigio gambe in metallo.
Chair with armrests upholstered in gray leatherette and fabric metal legs.

cm. L. 61 P. 64 H. 86,5 H.S. 48



Articolo LF2176
Sedia con braccioli imbottita
in similpelle grigio gambe in metallo.
Chair with armrests upholstered
in gray leatherette metal legs.
cm. L. 64 P. 62 H. 84 H.S. 48



Articolo LF2175
Sedia con braccioli imbottita
in similpelle beige gambe in metallo.
Chair with armrests upholstered
in beige leatherette metal legs.
cm. L. 64 P. 62 H. 84 H.S. 48



Articolo LF2171
Sedia con braccioli imbottita
in tessuto grigio gambe in metallo.
Chair with armrests upholstered
in gray fabric metal legs.
cm. L. 64 P. 62 H. 84 H.S. 48



Articolo LF2170
Sedia con braccioli imbottita
in tessuto beige gambe in metallo.
Chair with armrests upholstered
in beige fabric metal legs.
cm. L. 64 P. 62 H. 84 H.S. 48





Articolo LF2131

Sedia girevole con braccioli imbottita in similpelle e tessuto grigio gambe in metallo.
Swivel chair with armrests upholstered in leatherette and gray fabric metal legs.
cm. L. 65 P. 64 H. 83 H.S. 47



Articolo LF2130

Sedia girevole con braccioli imbottita in similpelle e tessuto beige gambe in metallo.
Swivel chair with armrests upholstered in leatherette and beige fabric metal legs.
cm. L. 65 P. 64 H. 83 H.S. 47



Articolo LF2141

Sedia girevole con braccioli imbottita in tessuto grigio gambe in metallo.
Swivel chair with armrests upholstered in gray fabric metal legs.
cm. L. 65 P. 64 H. 83 H.S. 47



Articolo LF2140

Sedia girevole con braccioli imbottita in tessuto beige gambe in metallo.
Swivel chair with armrests upholstered in beige fabric metal legs.
cm. L. 65 P. 64 H. 83 H.S. 47





Articolo LF2150
 Sedia con braccioli imbottita
 in tessuto beige gambe in metallo.
 Chair with armrests upholstered
 in beige fabric metal legs.
 cm. L. 65 P. 64 H. 83 H.S. 47



Articolo LF2151
 Sedia con braccioli imbottita
 in tessuto grigio gambe in metallo.
 Chair with armrests upholstered
 in gray fabric metal legs.
 cm. L. 65 P. 64 H. 83 H.S. 47



Articolo LF2155
 Sedia con braccioli imbottita
 in similpelle grigio gambe in metallo.
 Chair with armrests upholstered
 in gray leatherette metal legs.
 cm. L. 65 P. 64 H. 83 H.S. 47



Articolo LF2156
 Sedia con braccioli imbottita
 in similpelle marrone gambe in metallo.
 Chair with armrests upholstered
 in brown leatherette metal legs.
 cm. L. 65 P. 64 H. 83 H.S. 47



Articolo LF2200

Sedia con braccioli imbottita in tessuto grigio scuro e gambe in metallo nero.
Chair with armrests upholstered in dark gray fabric and black metal legs.
cm. L. 64 P. 64 H. 90 H.S. 55



Articolo LF2201

Sedia con braccioli imbottita in tessuto marrone gambe in metallo nero.
Chair with armrests upholstered in brown fabric and black metal legs.
cm. L. 64 P. 64 H. 90 H.S. 55



Articolo LF2160

Sedia con braccioli imbottita in tessuto verde scuro e gambe in metallo nero.
Chair with armrests upholstered in dark green fabric and black metal legs.
cm. L. 57,5 P. 65 H. 85 H.S. 52



Articolo LF2161

Sedia con braccioli imbottita in tessuto grigio scuro e gambe in metallo nero.
Chair with armrests upholstered in dark gray fabric and black metal legs.
cm. L. 57,5 P. 65 H. 85 H.S. 52



Articolo LF542
Sedia imbottita in similpelle beige a rombi.
Upholstered chair in beige rhombuses leatherette.
cm. L. 46 P. 56 H. 84 H.S. 46



Articolo LF544
Sedia imbottita in similpelle grigia a rombi.
Upholstered chair in gray rhombuses leatherette.
cm. L. 46 P. 56 H. 84 H.S. 46



Articolo LF548
Sedia imbottita in similpelle cuoio a rombi.
Upholstered chair in leather rhombuses leatherette.
cm. L. 46 P. 56 H. 84 H.S. 46



Articolo LF499
Sedia imbottita in similpelle grigia a rombi.
Upholstered chair in gray rhombuses leatherette.
cm. L. 43 P. 48 H. 87 H.S. 46,5



Articolo LF498
Sedia imbottita in similpelle cuoio a rombi.
Upholstered chair in leather rhombuses leatherette.
cm. L. 43 P. 48 H. 87 H.S. 46,5





Articolo LF2100
Sedia imbottita in similpelle beige e gambe in metallo. Upholstered chair in beige leatherette and metal legs. cm. L. 50,5 P. 62 H. 81,5 H.S. 47



Articolo LF2101
Sedia imbottita in similpelle grigio e gambe in metallo. Upholstered chair in gray leatherette and metal legs. cm. L. 50,5 P. 62 H. 81,5 H.S. 47



Articolo LF2103
Sedia imbottita in similpelle nero e gambe in metallo. Upholstered chair in black leatherette and metal legs. cm. L. 50,5 P. 62 H. 81,5 H.S. 47



Articolo LF2102
Sedia imbottita in similpelle marrone e gambe in metallo. Upholstered chair in brown leatherette and metal legs. cm. L. 50,5 P. 62 H. 81,5 H.S. 47



Articolo LF993

Sedia imbottita in tessuto denim slavato
rivestimento esterno similpelle brown.
Upholstered chair in washed denim fabric
with brown leatherette external covering.
cm. L. 48 P. 57 H. 81 H.S. 45

Articolo LF995

Sedia imbottita in velluto rigato beige
rivestimento esterno similpelle brown.
Upholstered chair in beige striped velvet
with brown leatherette external covering.
cm. L. 48 P. 57 H. 81 H.S. 45



Articolo LF992

Sedia imbottita in tessuto beige
rivestimento esterno similpelle brown.
Upholstered chair in beige fabric
with brown leatherette external covering.
cm. L. 48 P. 57 H. 81 H.S. 45



Articolo LF996

Sedia imbottita in velluto rigato grigio
rivestimento esterno similpelle brown.
Upholstered chair in gray striped velvet
with brown leatherette external covering.
cm. L. 48 P. 57 H. 81 H.S. 45



Articolo LF994

Sedia imbottita in tessuto blu
rivestimento esterno similpelle brown.
Upholstered chair in blue fabric
with brown leatherette external covering.
cm. L. 48 P. 57 H. 81 H.S. 45



Articolo LF290

Sedia imbottita in tessuto beige e fusto in metallo nero.
Upholstered chair in beige fabric and black metal frame.
cm. L. 46 P. 52 H. 81 H.S. 49



Articolo LF291

Sedia imbottita in tessuto grigio e fusto in metallo nero.
Upholstered chair in gray fabric and black metal frame.
cm. L. 46 P. 52 H. 81 H.S. 49



Articolo LF292

Sedia imbottita in tessuto arancione e fusto in metallo nero.
Upholstered chair in orange fabric and black metal frame.
cm. L. 46 P. 52 H. 81 H.S. 49



Articolo LF2205

Sedia con braccioli imbottita
in similpelle grigio gambe in metallo.
Chair with armrests upholstered
in gray leatherette metal legs.
cm. L. 67 P. 70 H. 94 H.S. 51



Articolo LF2206

Sedia con braccioli imbottita
in similpelle marrone fusto in metallo.
Chair with armrests upholstered
in brown leatherette metal legs.
cm. L. 67 P. 70 H. 94 H.S. 51



Articolo LF2215

Sedia con braccioli imbottita
in similpelle grigio fusto in metallo nero.
Chair with armrests upholstered
in gray leatherette black metal frame.
cm. L. 62 P. 58 H. 83 H.S. 50



Articolo LF2216

Sedia con braccioli imbottita
in similpelle marrone fusto in metallo nero.
Chair with armrests upholstered
in brown leatherette and black metal frame.
cm. L. 62 P. 58 H. 83 H.S. 50



Articolo LF2210

Sedia imbottita in similpelle grigio
gambe in metallo. Chair upholstered
in gray leatherette metal legs.
cm. L. 53 P. 60 H. 90 H.S. 48

Articolo LF2211

Sedia imbottita in similpelle marrone
gambe in metallo. Chair upholstered
in brown leatherette metal legs.
cm. L. 53 P. 60 H. 90 H.S. 48





Articolo LF2220

Sedia con braccioli imbottita in tessuto beige e fusto in metallo tortora.
Chair with armrests upholstered in beige fabric and taupe metal frame.
cm. L. 60 P. 60 H. 82 H.S. 49



Articolo LF2221

Sedia con braccioli imbottita in tessuto grigio scuro e fusto in metallo nero.
Chair with armrests upholstered in dark grey fabric and black metal frame.
cm. L. 60 P. 60 H. 82 H.S. 49



Articolo LF2226

Sedia imbottita in similpelle e tessuto grigio scuro e fusto in metallo tortora.
Chair upholstered in leatherette and dark gray fabric and dove gray metal frame.
cm. L. 54,5 P. 58 H. 79 H.S. 48



Articolo LF2225

Sedia imbottita in similpelle e tessuto arancione e fusto in metallo tortora.
Chair upholstered in leatherette and orange fabric and dove gray metal frame.
cm. L. 54,5 P. 58 H. 79 H.S. 48





Articolo LF268

Sedia imbottita in similpelle grigio con fusto grigio.
Upholstered chair in gray leatherette with gray frame.
cm. L. 46 P. 54 H. 99 H.S. 48



Articolo LF267

Sedia imbottita in similpelle beige con fusto beige.
Upholstered chair in beige leatherette with beige frame.
cm. L. 46 P. 54 H. 99 H.S. 48



Articolo LF249

Sedia imbottita in similpelle marrone con fusto wengé.
Upholstered chair in brown leatherette with wenge frame.
cm. L. 46 P. 49 H. 99 H.S. 47,5



Articolo LF250

Sedia imbottita in similpelle beige con fusto bianco.
Upholstered chair in beige leatherette with white frame.
cm. L. 46 P. 49 H. 99 H.S. 47,5



Articolo LF258

Sedia imbottita in similpelle beige con fusto rovere.
Upholstered chair in beige leatherette with oak wood frame.
cm. L. 46 P. 45 H. 100 H.S. 48

Articolo LF254

Sedia imbottita in similpelle marrone con fusto wengé. Upholstered chair in brown leatherette with wenge frame.
cm. L. 46 P. 45 H. 100 H.S. 48



Articolo LF269

Sedia imbottita in similpelle antracite con fusto antracite.
Upholstered chair in anthracite leatherette with anthracite frame.
cm. L. 46 P. 45 H. 100 H.S. 48

Articolo LF265

Sedia imbottita in similpelle beige con fusto beige.
Upholstered chair in beige leatherette with beige frame.
cm. L. 46 P. 45 H. 100 H.S. 48

Articolo LF259

Sedia imbottita in similpelle grigio con fusto grigio.
Upholstered chair in gray leatherette with gray frame.
cm. L. 46 P. 45 H. 100 H.S. 48

Articolo LF256

Sedia imbottita in similpelle tortora con fusto tortora.
Upholstered chair in taupe leatherette with taupe frame.
cm. L. 46 P. 45 H. 100 H.S. 48



Articolo LF248
 Sgabello imbottito in similpelle
 tortora con fusto tortora.
 Upholstered stool in taupe
 leatherette with taupe frame.
 cm. L. 46 P. 49 H. 106 H.S. 74



Articolo LF251
 Sgabello imbottito in similpelle
 beige con fusto bianco.
 Upholstered stool in beige
 leatherette with white frame.
 cm. L. 46 P. 49 H. 106 H.S. 74



Articolo LF244
 Sgabello imbottito in similpelle
 beige con fusto rovere.
 Upholstered stool in beige
 leatherette with oak wood frame.
 cm. L. 46 P. 49 H. 106 H.S. 74



Articolo LF247
 Sgabello imbottito in similpelle
 antracite con fusto antracite.
 Upholstered stool in brown
 leatherette with anthracite frame.
 cm. L. 46 P. 49 H. 106 H.S. 74



Articolo LF243
 Sgabello imbottito in similpelle
 marrone con fusto wengé.
 Upholstered stool in brown
 leatherette with wenge frame.
 cm. L. 46 P. 49 H. 106 H.S. 74



Articolo LF266
Sedia imbottita in similpelle beige con bottoni e fusto beige.
Upholstered chair in beige leatherette with buttons and beige frame.
cm. L. 46 P. 45 H. 100 H.S. 48



Articolo LF264
Sedia imbottita in similpelle beige con bottoni e fusto rovere.
Upholstered chair in beige leatherette with buttons and oak wood frame.
cm. L. 46 P. 45 H. 100 H.S. 48



Articolo LF261
Sedia imbottita in similpelle marrone con bottoni e fusto wengé.
Upholstered chair in brown leatherette with buttons and wenge frame.
cm. L. 46 P. 45 H. 100 H.S. 48



Articolo LF287

Sedia imbottita in similpelle invecchiata grigio con bottoni e fusto grigio.
Upholstered chair in gray aged leatherette with buttons and gray frame.
cm. L. 46 P. 45 H. 100 H.S. 48



Articolo LF286

Sedia imbottita in similpelle invecchiata marrone con bottoni e fusto wengé.
Upholstered chair in brown aged leatherette with buttons and wenge frame.
cm. L. 46 P. 45 H. 100 H.S. 48



Articolo LF285

Sedia imbottita in similpelle invecchiata beige con bottoni e fusto tortora.
Upholstered chair in beige aged leatherette with buttons and taupe frame.
cm. L. 46 P. 45 H. 100 H.S. 48





Articolo LF282
Sedia imbottita in similpelle
invecchiata grigio con fusto grigio.
Upholstered chair in gray aged
leatherette with gray frame.
cm. L. 46 P. 45 H. 100 H.S. 48



Articolo LF281
Sedia imbottita in similpelle
invecchiata marrone con fusto wengé.
Upholstered chair in brown aged
leatherette with wenge frame.
cm. L. 46 P. 45 H. 100 H.S. 48



Articolo LF280
Sedia imbottita in similpelle
invecchiata beige con fusto tortora.
Upholstered chair in beige aged
leatherette with taupe frame.
cm. L. 46 P. 45 H. 100 H.S. 48



Articolo LF496

Sedia imbottita in tessuto rosso
con gambe metallo nero.
Upholstered chair in red fabric
with black metal legs.
cm. L. 52 P. 52 H. 80 H.S. 47



Articolo LF479

Sedia imbottita in tessuto azzurro
con rivestimento esterno in similpelle grigio.
Upholstered chair in light blue fabric
with external cover in gray leatherette.
cm. L. 57 P. 50 H. 83 H.S. 46



Articolo LF477

Sedia imbottita in tessuto beige
con rivestimento esterno in similpelle nero.
Upholstered chair in beige fabric
with external cover in black leatherette.
cm. L. 57 P. 50 H. 83 H.S. 46



Articolo LF432

Sedia imbottita in similpelle rosso
con bottoni, gambe metallo e legno.
Upholstered chair in red leatherette
with buttons, metal and wooden legs.
cm. L. 44 P. 54 H. 82 H.S. 45



Articolo LF432 C

Sedia imbottita in similpelle rosso
con bottoni, gambe metallo cromato.
Upholstered chair in red leatherette
with buttons and chromed metal legs.
cm. L. 44 P. 54 H. 82 H.S. 45





Articolo LF207Z
Sedia imbottita Inghilterra
basamento metallo nero.
Upholstered chair England
basement black metal.
cm. L. 46 P. 56 H. 90 H.S. 51



Articolo LF206Z
Sedia imbottita Time
basamento metallo nero.
Upholstered chair Time
basement black metal.
cm. L. 46 P. 56 H. 90 H.S. 51



Articolo LF208Z
Sedia imbottita City
basamento metallo nero.
Upholstered chair City
basement black metal.
cm. L. 46 P. 56 H. 90 H.S. 51



Articolo LF209Z
Sedia imbottita similpelle beige
basamento metallo nero.
Upholstered chair beige leatherette
basement black metal.
cm. L. 46 P. 56 H. 90 H.S. 51



Articolo LF699
Sedia imbottita in tessuto grigio
struttura in polipropilene.
Upholstered chair in gray fabric
polypropylene structure.
cm. L. 53 P. 62 H. 85 H.S. 45



Articolo LF651
Sedia imbottita in velluto blu
basamento in metallo tortora.
Upholstered chair in blue velvet
with taupe metal basement.
cm. L. 50 P. 52 H. 83 H.S. 47



Articolo LF540
Sedia imbottita
in similpelle bianco con bordo nero.
Upholstered chair in white
leatherette with black edge.
cm. L. 50 P. 50 H. 98 H.S. 46



Articolo LF665
Sedia patchwork imbottita in tessuto grigio azzurro con gambe in legno.
Upholstered patchwork chair in gray light blue fabric with wooden legs.
cm. L. 47 P. 58 H. 84 H.S. 48



Articolo LF663
Sedia patchwork imbottita in tessuto grigio azzurro gambe in legno e metallo.
Upholstered patchwork chair in gray light blue fabric wooden and metal legs.
cm. L. 47 P. 58 H. 84 H.S. 48



Articolo LF684
Sedia patchwork imbottita in tessuto grigio azzurro gambe in legno e metallo.
Upholstered patchwork chair in gray light blue fabric wooden and metal legs.
cm. L. 47 P. 58 H. 84 H.S. 48



Articolo LF656
Sedia patchwork imbottita in tessuto grigio azzurro gambe in metallo cromato.
Upholstered patchwork chair in gray light blue fabric and chromed metal legs.
cm. L. 47 P. 58 H. 84 H.S. 48



Articolo LF660
Poltroncina a dondolo patchwork imbottita in tessuto grigio azzurro gambe in metallo cromato e legno.
Patchwork rocking armchair upholstered in gray light blue fabric chromed metal and wooden legs.
cm. L. 62 P. 69 H. 70 H.S. 43



Articolo LF443
Poltroncina a dondolo patchwork imbottita in tessuto multicolor gambe in metallo cromato e legno.
Patchwork rocking armchair upholstered in fabric multicolored chromed metal and wooden legs.
cm. L. 62 P. 69 H. 70 H.S. 43



Articolo LF685

Poltroncina patchwork imbottita in tessuto grigio azzurro gambe in metallo e legno.
Patchwork armchair upholstered in gray light blue fabric metal and wooden legs.
cm. L. 62 P. 65 H. 79 H.S. 48



Articolo LF661

Poltroncina patchwork imbottita in tessuto grigio azzurro e gambe in legno.
Patchwork armchair upholstered in gray light blue fabric and wooden legs.
cm. L. 62 P. 65 H. 79 H.S. 48



Articolo LF666

Poltroncina patchwork imbottita in tessuto grigio azzurro gambe in metallo e legno.
Patchwork armchair upholstered in gray light blue fabric metal and wooden legs.
cm. L. 62 P. 65 H. 79 H.S. 48



Articolo LF679

Poltroncina patchwork imbottita in tessuto multicolor gambe in metallo e legno.
Patchwork armchair upholstered in fabric multicolored metal and wooden legs.
cm. L. 62 P. 65 H. 79 H.S. 48



Articolo LF446

Poltroncina patchwork imbottita in tessuto multicolor e gambe in legno.
Patchwork armchair upholstered in fabric multicolored and wooden legs.
cm. L. 62 P. 65 H. 79 H.S. 48



Articolo LF662

Poltroncina patchwork imbottita in tessuto multicolor gambe in metallo e legno.
Patchwork armchair upholstered in fabric multicolored metal and wooden legs.
cm. L. 62 P. 65 H. 79 H.S. 48



Articolo LF2200

Sedia con braccioli imbottita in tessuto grigio scuro e gambe in metallo nero.
Chair with armrests upholstered in dark gray fabric and black metal legs.
cm. L. 64 P. 64 H. 90 H.S. 55

Articolo LF548

Sedia imbottita in similpelle cuoio a rombi.
Upholstered chair in leather rhombuses leatherette.
cm. L. 46 P. 56 H. 84 H.S. 46



LEGNO

UN'ABITAZIONE RICAVATA DA UN AMBIENTE UNICO, Scopri sedie, poltrone, tavoli e complementi di design che si combinano con i mobili della tua sala da pranzo, soggiorno, cucina o terrazza. Trova l'opzione migliore per le tue stanze, scopri materiali, stili e colori esclusivi per differenziare la tua casa, trasformala in uno spazio comodo e piacevole per te e i tuoi ospiti. Sedie, tavoli e complementi di design ideale per la tua casa o il tuo spazio di lavoro, che si tratti di sedie in legno, sedie in plastica, metallo o sedie moderne a seconda del colore, come sedie gialle, sedie trasparenti, sedie nere, tra molte altre. Abbiamo anche sedie, poltrone, tavoli e complementi a seconda dello spazio in cui verranno collocate, dalle sedie da pranzo alle sedie da giardino. La nostra collezione offre una vasta gamma di mobili per soddisfare sia le impostazioni casual che quelle formali per la tua casa o lo spazio di lavoro.

A HOUSE OBTAINED FROM A UNIQUE ENVIRONMENT, Discover chairs, armchairs, tables and design accessories that combine with the furniture in your dining room, living room, kitchen or terrace. Find the best option for your rooms, discover exclusive materials, styles and colors to differentiate your home, transform it into a comfortable and pleasant space for you and your guests. Chairs, tables and design accessories ideal for your home or workspace, whether it's wooden chairs, plastic chairs, metal or modern chairs depending on the color, such as yellow chairs, transparent chairs, black chairs, among many others. We also have chairs, armchairs, tables and accessories depending on the space in which they will be placed, from dining chairs to garden chairs. Our collection offers a wide variety of furniture to suit both casual and formal settings for your home or workspace.



COLORI. COLOURS.



Bianco.
White.



Grigio.
Gray.



Articolo 326 GL BIANCO
Sedia laccata bianco con fondino legno.
White lacquered chair with wooden seat.
cm. L. 43 P. 46 H. 81,5 H.S. 46,5

Articolo 326 GL GRIGIO
Sedia laccata grigio con fondino legno.
Gray lacquered chair with wooden seat.
cm. L. 43 P. 46 H. 81,5 H.S. 46,5





Articolo 326 GSL BIANCO
 Sgabello laccato bianco con fondino legno.
 White lacquered stool with wooden seat.
 cm. L. 39 P. 45 H. 110 H.S. 79



Articolo 326 GSL GRIGIO
 Sgabello laccato grigio con fondino legno.
 Gray lacquered stool with wooden seat.
 cm. L. 39 P. 45 H. 110 H.S. 79

COLORI. COLOURS.

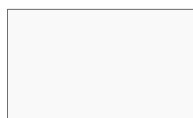

Bianco.
 White.



Grigio.
 Gray.



Nero.
 Black.



Articolo LF936
 Sedia laccata bianco con schienale
 paglia di Vienna e fondino legno.
 White lacquered chair with backrest
 Vienna straw and wooden seat.
 cm. L. 45 P. 47 H. 87 H.S. 47



Articolo LF937
 Sedia laccata grigio con schienale
 paglia di Vienna e fondino legno.
 Gray lacquered chair with backrest
 Vienna straw and wooden seat.
 cm. L. 45 P. 47 H. 87 H.S. 47



Articolo LF896
 Sedia laccata nero con schienale
 paglia di Vienna e fondino legno.
 Black lacquered chair with backrest
 Vienna straw and wooden seat.
 cm. L. 45 P. 47 H. 87 H.S. 47

COLORI. COLOURS.



Bianco.
White.



Grigio.
Gray.



Noce.
Walnut.



Articolo 310 GBPE
Sedia laccata bianco con fondino paglia.
White lacquered chair with straw seat.
cm. L. 43 P. 42 H. 88 H.S. 47



Articolo 310 GLPE
Sedia noce con fondino paglia.
Walnut wood chair with straw seat.
cm. L. 43 P. 42 H. 88 H.S. 47



Articolo 310 GLLE
Sedia noce con fondino legno.
Walnut wood chair with wooden seat.
cm. L. 43 P. 42 H. 88 H.S. 47



Articolo 310 GBLE
Sedia laccata bianco con fondino legno.
White lacquered chair with wooden seat.
cm. L. 43 P. 42 H. 88 H.S. 47



Articolo 310 GSL BIANCO
Sgabello laccato bianco con fondino legno.
White lacquered stool with wooden seat.
cm. L. 41 P. 44 H. 101 H.S. 73



Articolo 310 GSL GRIGIO
Sgabello laccato grigio con fondino legno.
Gray lacquered stool with wooden seat.
cm. L. 41 P. 44 H. 101 H.S. 73



Articolo 310 GP ROSSO
Sedia anilina rossa con fondino paglia.
Red aniline chair with straw seat.
cm. L. 43 P. 42 H. 88 H.S. 47



Articolo 310 GP BLU
Sedia anilina blu con fondino paglia.
Blue aniline chair with straw seat.
cm. L. 43 P. 42 H. 88 H.S. 47



Articolo 310 GP GIALLO
Sedia anilina gialla con fondino paglia.
Yellow aniline chair with straw seat.
cm. L. 43 P. 42 H. 88 H.S. 47



Articolo 310 GP VERDE
Sedia anilina verde con fondino paglia.
Green aniline chair with straw seat.
cm. L. 43 P. 42 H. 88 H.S. 47



Articolo 310 GP NERO
Sedia anilina nera con fondino paglia.
Black aniline chair with straw seat.
cm. L. 43 P. 42 H. 88 H.S. 47



Articolo 310 GP BIANCO
Sedia anilina bianca con fondino paglia.
White aniline chair with straw seat.
cm. L. 43 P. 42 H. 88 H.S. 47



Articolo 310 GP TRASPARENTE
Sedia anilina naturale con fondino paglia.
Natural aniline chair with straw seat.
cm. L. 43 P. 42 H. 88 H.S. 47



Articolo 310 GBI LILLA

Sedia laccata bianco con fondino similpelle.
White lacquered chair with leatherette seat.
cm. L. 43 P. 42 H. 88 H.S. 47



Articolo 310 GBI CREMA



Articolo 310 GBI GIALLO



Articolo 310 GBI LIME



Articolo 310 GBI LILLA

SEDIE IMBOTTITE COLORATE. Per gli amanti dello stile classico, le sedie con fondino imbottito colorato rappresentano una scelta di classe. Le nostre sedie, oltre ad essere funzionali, diventano veri e propri elementi d'arredo che donano carattere e personalità all'ambiente.

COLORFUL UPHOLSTERED CHAIRS. For lovers of classic style, chairs with colored upholstered seats are a classy choice. Our chairs, in addition to being functional, become real furnishing elements that give character and personality to the environment.



Articolo 325 GBI CREMA



Articolo 325 GBI AZZURRO



Articolo 325 GBI LILLA



Articolo 325 GBI GRIGIO



Articolo 325 GBI GIALLO



Articolo 325 GBI LIME



Articolo 325 GBI ARANCIONE

Articolo 325 GBI LIME

Sedia laccata bianco con fondino similpelle.
White lacquered chair with leatherette seat.
cm. L. 43 P. 42 H. 90 H.S. 46,5



Fondino paglia. Straw seat.



Fondino legno. Wooden seat.



Articolo 325 GLPE
Sedia noce con fondino paglia.
Walnut chair with straw seat.
cm. L. 43 P. 42 H. 90 H.S. 46,5



Articolo 325 GLE
Sedia noce con fondino legno.
Walnut chair with wooden seat.
cm. L. 43 P. 42 H. 90 H.S. 46,5



Articolo 325 GBPE
Sedia laccata bianco con fondino paglia.
White lacquered chair with straw seat.
cm. L. 43 P. 42 H. 90 H.S. 46,5



Articolo 325 GBLE
Sedia laccata bianco con fondino legno.
White lacquered chair with wooden seat.
cm. L. 43 P. 42 H. 90 H.S. 46,5



Articolo 381 GBPE
Sedia laccata bianco con fondino paglia.
White lacquered chair with straw seat.
cm. L. 46 P. 50 H. 95 H.S. 47,5



Articolo 381 GBLE
Sedia laccata bianco con fondino legno.
White lacquered chair with wooden seat.
cm. L. 46 P. 50 H. 95 H.S. 47,5



Articolo 381 GLPE
Sedia noce con fondino paglia.
Walnut chair with straw seat.
cm. L. 46 P. 50 H. 95 H.S. 47,5



Articolo 381 GLE
Sedia noce con fondino legno.
Walnut chair with wooden seat.
cm. L. 46 P. 50 H. 95 H.S. 47,5



Articolo LF235 GL GRIGIO
Sedia laccata grigio con fondino legno.
Gray lacquered chair with wooden seat.
cm. L. 43 P. 48 H. 87 H.S. 46,5



Articolo LF235 GL BIANCO
Sedia laccata bianco con fondino legno.
White lacquered chair with wooden seat.
cm. L. 43 P. 48 H. 87 H.S. 46,5



Articolo LF235 GV GRIGIO
Sedia laccata grigio con schienale paglia di vienna e fondino legno.
Gray lacquered chair with backrest Vienna straw and wooden seat.
cm. L. 43 P. 48 H. 87 H.S. 46,5



Articolo LF235 GV BIANCO
Sedia laccata bianco con schienale paglia di vienna e fondino legno.
White lacquered chair with backrest Vienna straw and wooden seat.
cm. L. 43 P. 48 H. 87 H.S. 46,5



Articolo LF242 GBL
Sedia laccata bianco con fondino legno.
White lacquered chair with wooden seat.
cm. L. 40 P. 37 H. 81 H.S. 45

METALLO

UN'ABITAZIONE RICAVATA DA UN AMBIENTE UNICO, Scopri sedie, poltrone, tavoli e complementi di design che si combinano con i mobili della tua sala da pranzo, soggiorno, cucina o terrazza. Trova l'opzione migliore per le tue stanze, scopri materiali, stili e colori esclusivi per differenziare la tua casa, trasformala in uno spazio comodo e piacevole per te e i tuoi ospiti. Sedie, tavoli e complementi di design ideale per la tua casa o il tuo spazio di lavoro, che si tratti di sedie in legno, sedie in plastica, metallo o sedie moderne a seconda del colore, come sedie gialle, sedie trasparenti, sedie nere, tra molte altre. Abbiamo anche sedie, poltrone, tavoli e complementi a seconda dello spazio in cui verranno collocate, dalle sedie da pranzo alle sedie da giardino. La nostra collezione offre una vasta gamma di mobili per soddisfare sia le impostazioni casual che quelle formali per la tua casa o lo spazio di lavoro.

A HOUSE OBTAINED FROM A UNIQUE ENVIRONMENT, Discover chairs, armchairs, tables and design accessories that combine with the furniture in your dining room, living room, kitchen or terrace. Find the best option for your rooms, discover exclusive materials, styles and colors to differentiate your home, transform it into a comfortable and pleasant space for you and your guests. Chairs, tables and design accessories ideal for your home or workspace, whether it's wooden chairs, plastic chairs, metal or modern chairs depending on the color, such as yellow chairs, transparent chairs, black chairs, among many others. We also have chairs, armchairs, tables and accessories depending on the space in which they will be placed, from dining chairs to garden chairs. Our collection offers a wide variety of furniture to suit both casual and formal settings for your home or workspace.



COLORI. COLOURS.



Tortora.
Taupe.



Antracite.
Anthracite.



Articolo LF2300

Sedia con braccioli in metallo antracite, schienale in corda antracite, seduta con cuscino in tessuto antracite.
Chair with black metal armrests, anthracite rope backrest, anthracite fabric seat and cushion.
cm. L. 62 P. 48 H. 78 H.S. 44



Articolo LF2301

Sedia con braccioli in metallo tortora, schienale in corda tortora, seduta con cuscino in tessuto beige.
Chair with taupe metal armrests, taupe rope backrest, beige fabric seat and cushion.
cm. L. 62 P. 48 H. 78 H.S. 44



Articolo LF2316

Sedia con braccioli in metallo tortora, schienale e seduta in corda tortora.
Chair with taupe metal armrests, taupe rope backrest and seat.
cm. L. 57 P. 55 H. 77 H.S. 46



Articolo LF2315

Sedia con braccioli in metallo antracite, schienale e seduta in corda antracite.
Chair with anthracite metal armrests, anthracite rope backrest and seat.
cm. L. 57 P. 55 H. 77 H.S. 46





Articolo LF2306

Sedia con braccioli in metallo tortora, schienale e seduta in corda tortora.

Chair with taupe metal armrests, taupe rope backrest and seat.

cm. L. 56 P. 53 H. 78 H.S. 44



Articolo LF2305

Sedia con braccioli in metallo antracite, schienale e seduta in corda antracite.

Chair with anthracite metal armrests, anthracite rope backrest and seat.

cm. L. 56 P. 53 H. 78 H.S. 44



COLORI. COLOURS.



Tortora.
Taupe.

Antracite.
Anthracite.



Articolo LF2320

Sedia con braccioli in metallo antracite,
schienale e seduta in corda antracite.
Chair with anthracite metal armrests,
anthracite rope backrest and seat.
cm. L. 59 P. 57 H. 77 H.S. 44



Articolo LF2321

Sedia con braccioli in metallo tortora,
schienale e seduta in corda tortora.
Chair with taupe metal armrests,
taupe rope backrest and seat.
cm. L. 59 P. 57 H. 77 H.S. 44



Articolo LF2326

Sedia in metallo tortora
schienale e seduta in corda tortora.
Taupe metal chair
with taupe rope back and seat.
cm. L. 52 P. 57 H. 77 H.S. 44



Articolo LF2325

Sedia in metallo antracite
schienale e seduta in corda antracite.
Anthracite metal chair
with anthracite rope back and seat.
cm. L. 52 P. 57 H. 77 H.S. 44



Articolo LF2310

Sedia con braccioli in metallo antracite,
schienale e seduta in corda antracite.

Chair with anthracite metal armrests,
anthracite rope backrest and seat.

cm. L. 58 P. 53 H. 86 H.S. 46



Articolo LF2311

Sedia con braccioli in metallo tortora,
schienale e seduta in corda tortora.

Chair with taupe metal armrests,
taupe rope backrest and seat.

cm. L. 58 P. 53 H. 86 H.S. 46





Articolo LF960
Sedia in metallo nero
con seduta in corda antracite.
Chair in black metal
with anthracite rope seat.
cm. L. 50 P. 63 H. 88 H.S. 41



Articolo LF961
Sedia in metallo bianco
con seduta in corda grigio.
Chair in white metal
with gray rope seat.
cm. L. 50 P. 63 H. 88 H.S. 41



Articolo LF964
Sgabello in metallo nero
con seduta in corda antracite.
Black metal stool
with seat in anthracite rope.
cm. L. 60 P. 59 H. 106 H.S. 75



Articolo LF963
Poltrona con braccioli in metallo
bianco con seduta in corda grigio.
Armchair with armrests in white
metal with gray rope seat.
cm. L. 60 P. 63 H. 91 H.S. 43



Articolo LF986
Poltrona in metallo colore bianco.
White metal armchair.
cm. L. 57 P. 61 H. 87 H.S. 44



Articolo LF561
Sedia in metallo bianco lucido.
Glossy white metal chair.
cm. L. 41 P. 46 H. 83 H.S. 44

COLORI. COLOURS.



Tortora.
Taupe.



Antracite.
Anthracite.

METALLO



Articolo LF6525

Sedia alluminio color tortora.
Aluminum chair in taupe color.
cm. L. 43 P. 57,5 H. 83 H.S. 45



Articolo LF6530

Sgabello alluminio color tortora.
Aluminum stool in taupe color.
cm. L. 43 P. 57,5 H. 103 H.S. 73



Articolo LF6521

Poltrona alluminio color antracite.
Aluminum armchair in anthracite color.
cm. L. 58 P. 54 H. 81 H.S. 46



Articolo LF6520

Poltrona alluminio color tortora.
Aluminum armchair in taupe color.
cm. L. 58 P. 54 H. 81 H.S. 46



COLORI. COLOURS.



Bianco.
White.



Grigio.
Gray.



Articolo LF939

Poltrona in metallo bianco
con fondino similpelle bianco.
White metal armchair
with white eco-leather seat.
cm. L. 58 P. 54 H. 81 H.S. 46



Articolo LF934

Sedia in metallo bianco
con fondino similpelle bianco.
White metal chair
with white eco-leather seat.
cm. L. 48 P. 52 H. 80 H.S. 46



Articolo LF931

Sgabello in metallo grigio
con fondino similpelle grigio.
Gray metal stool
with gray eco-leather seat.
cm. L. 49 P. 50 H. 97 H.S. 78



Articolo LF940

Poltrona in metallo grigio
con fondino similpelle grigio.
Gray metal armchair
with gray eco-leather seat.
cm. L. 58 P. 54 H. 81 H.S. 46



Articolo LF935

Sedia in metallo grigio
con fondino similpelle grigio.
Gray metal chair
with gray eco-leather seat.
cm. L. 48 P. 52 H. 80 H.S. 46

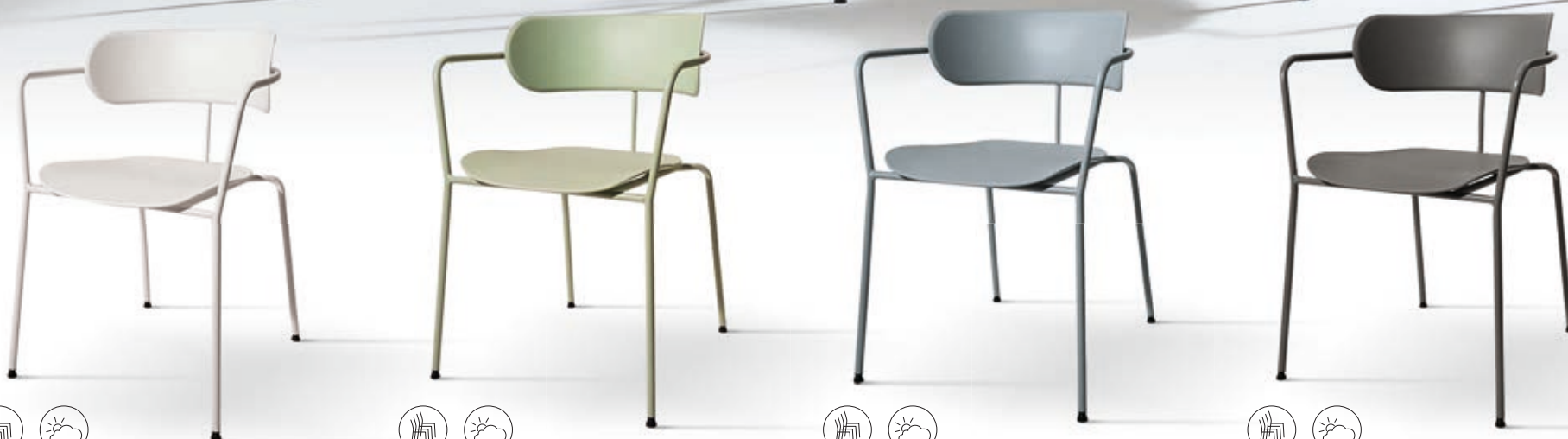

**Articolo LF968**

Poltrona in metallo bianco seduta e schienale polipropilene bianco.
White metal armchair with white polypropylene seat and back.
cm. L. 55 P. 54 H. 76 H.S. 45

**Articolo LF969**

Poltrona in metallo verde seduta e schienale polipropilene verde.
Green metal armchair with green polypropylene seat and back.
cm. L. 55 P. 54 H. 76 H.S. 45

**Articolo LF967**

Poltrona in metallo azzurro seduta e schienale polipropilene azzurro.
Light blue metal armchair with light blue polypropylene seat and back.
cm. L. 55 P. 54 H. 76 H.S. 45

**Articolo LF966**

Poltrona in metallo grigio seduta e schienale polipropilene grigio.
Gray metal armchair with gray polypropylene seat and back.
cm. L. 55 P. 54 H. 76 H.S. 45

**Articolo LF984**

Sgabello in metallo verde seduta e schienale polipropilene verde.
Green metal stool with green polypropylene seat and back.
cm. L. 43 P. 51,5 H. 108 H.S. 75,5

**Articolo LF982**

Sgabello in metallo azzurro seduta e schienale polipropilene azzurro.
Light blue metal stool with light blue polypropylene seat and back.
cm. L. 43 P. 51,5 H. 108 H.S. 75,5





Articolo LF210 NOCE INVECCHIATO

Sedia scuola fusto metallo canna di fucile seduta e schienale melaminico noce invecchiato. School chair with gun metal frame seat and back in aged walnut melamine. cm. L. 43,5 P. 50 H. 82,5 H.S. 46



Articolo LF211 NOCE INVECCHIATO

Sgabello scuola fusto metallo canna di fucile seduta e schienale melaminico noce invecchiato. School stool gun metal frame seat and back in aged walnut melamine. cm. L. 43 P. 47,5 H. 117 H.S. 81



Articolo LF213 NOCE INVECCHIATO

Sgabello girevole scuola fusto metallo canna di fucile seduta melaminico noce invecchiato. Revolving school stool with gun metal frame seat in aged walnut melamine. cm. L. 38 P. 47,5 H. 71/81

COLORI. COLOURS.



Canna di fucile.
Gunmetal metal.



Noce invecchiato.
Aged walnut.



Metallo nero.
Black metal.



Melaminico noce.
Walnut melamine.



Articolo LF217

Ssgabello scuola fusto metallo nero e seduta melaminico nero. School stool black metal frame and black melamine seat. cm. L. 32 P. 32 H. 46,5

COLORI. COLOURS.



Metallo nero.
Black metal.



Melaminico nero.
Black melamine.



Articolo LF218

Sgabello scuola fusto metallo bianco e seduta melaminico bianco. School stool white metal frame and white melamine seat. cm. L. 32 P. 32 H. 46,5



Metallo bianco.
White metal.



Melaminico bianco.
White melamine.



Articolo LF215

Sgabello scuola fusto metallo nero seduta e schienale melaminico noce. School stool black metal frame walnut melamine seat and back. cm. L. 43 P. 47,5 H. 117 H.S. 81

COLORI. COLOURS.



Metallo bianco.
White metal.



Melaminico bianco.
White melamine.



Metallo grigio.
Gray metal.



Melaminico grigio.
Gray melamine.



Canna di fucile.
Gunmetal metal.



Noce invecchiato.
Aged walnut.



Articolo LF853

Banco scuola fusto metallo grigio
e piano melaminico grigio.
School desk gray metal frame
and gray melamine top.
cm. L. 70 P. 50 H. 76,5



Articolo LF843

Banco scuola fusto metallo canna di fucile
e piano melaminico noce invecchiato.
School desk gun metal frame
and aged walnut melamine top.
cm. L. 70 P. 50 H. 76,5



Articolo LF849

Banco scuola fusto metallo bianco
e piano melaminico bianco.
School desk white metal frame
and white melamine top.
cm. L. 70 P. 50 H. 76,5

**Articolo LF571**

Sedia in metallo giallo anticato.
Antique yellow metal chair.
cm. L. 45 P. 50 H. 85 H.S. 46

**Articolo LF572**

Sedia in metallo verde acqua anticato.
Antique water green metal chair.
cm. L. 45 P. 50 H. 85 H.S. 46

**Articolo LF573**

Sedia in metallo arancione anticato.
Antique orange metal chair.
cm. L. 45 P. 50 H. 85 H.S. 46

**Articolo LF574**

Sedia in metallo azzurro anticato.
Antique sky blue metal chair.
cm. L. 45 P. 50 H. 85 H.S. 46

**Articolo LF564**

Sedia in metallo specchiato.
Mirrored metal chair.
cm. L. 45 P. 50 H. 85 H.S. 46

**Articolo LF567**

Sedia in metallo grigio metallizzato.
Metallic gray metal chair.
cm. L. 45 P. 50 H. 85 H.S. 46

**Articolo LF569**

Sedia in metallo canna di fucile.
Gunmetal metal chair.
cm. L. 45 P. 50 H. 85 H.S. 46

**Articolo LF566**

Sedia in metallo bianco lucido.
Glossy white metal chair.
cm. L. 45 P. 50 H. 85 H.S. 46

**Articolo LF581**

Sgabello alto in metallo canna di fucile.
High stool in gunmetal metal.
cm. L. 43 P. 43 H. 77

**Articolo LF556**

Sgabello in metallo con schienale canna di fucile.
Metal stool with backrest in gunmetal metal.
cm. L. 43 P. 43 H. 94 H.S. 76

**Articolo LF559**

Sgabello in metallo specchiato con schienale.
Stool in mirrored metal with backrest.
cm. L. 43 P. 43 H. 94 H.S. 76

**Articolo LF582**

Sgabello in metallo con schienale canna di fucile.
Metal stool with backrest in gunmetal metal.
cm. L. 45 P. 43 H. 120 H.S. 77

**Articolo LF587**

Sgabello in metallo con schienale grigio metallizzato.
Metal stool with backrest in metallic gray metal.
cm. L. 45 P. 43 H. 120 H.S. 77

**Articolo LF568**

Sgabello in metallo con schienale silver.
Metal stool with silver backrest.
cm. L. 45 P. 43 H. 120 H.S. 77



Articolo LF557
Sedia in metallo grigio metallizzato.
Chair in metallic gray metal.
cm. L. 53 P. 54 H. 72 H.S. 45



Articolo LF580
Sgabello basso in metallo canna di fucile.
Low stool in gunmetal metal.
cm. L. 39 P. 39 H. 46



Articolo LF688
Sgabello alto in metallo specchiato.
High stool in mirrored metal.
cm. L. 47 P. 47 H. 76



Articolo LF687
Sgabello alto in metallo canna di fucile.
High stool in gunmetal metal.
cm. L. 47 P. 47 H. 76



Articolo LF681
Sedia in metallo bianco opaco.
Matt White metal chair.
cm. L. 43,5 P. 51 H. 83 H.S. 45



Articolo LF682
Sedia in metallo specchiato.
Mirrored metal chair.
cm. L. 43,5 P. 51 H. 83 H.S. 45

TAVOLI

UN'ABITAZIONE RICAVATA DA UN AMBIENTE UNICO, Scopri sedie, poltrone, tavoli e complementi di design che si combinano con i mobili della tua sala da pranzo, soggiorno, cucina o terrazza. Trova l'opzione migliore per le tue stanze, scopri materiali, stili e colori esclusivi per differenziare la tua casa, trasformala in uno spazio comodo e piacevole per te e i tuoi ospiti. Sedie, tavoli e complementi di design ideale per la tua casa o il tuo spazio di lavoro, che si tratti di sedie in legno, sedie in plastica, metallo o sedie moderne a seconda del colore, come sedie gialle, sedie trasparenti, sedie nere, tra molte altre. Abbiamo anche sedie, poltrone, tavoli e complementi a seconda dello spazio in cui verranno collocate, dalle sedie da pranzo alle sedie da giardino. La nostra collezione offre una vasta gamma di mobili per soddisfare sia le impostazioni casual che quelle formali per la tua casa o lo spazio di lavoro.

A HOUSE OBTAINED FROM A UNIQUE ENVIRONMENT, Discover chairs, armchairs, tables and design accessories that combine with the furniture in your dining room, living room, kitchen or terrace. Find the best option for your rooms, discover exclusive materials, styles and colors to differentiate your home, transform it into a comfortable and pleasant space for you and your guests. Chairs, tables and design accessories ideal for your home or workspace, whether it's wooden chairs, plastic chairs, metal or modern chairs depending on the color, such as yellow chairs, transparent chairs, black chairs, among many others. We also have chairs, armchairs, tables and accessories depending on the space in which they will be placed, from dining chairs to garden chairs. Our collection offers a wide variety of furniture to suit both casual and formal settings for your home or workspace.





COLORI. COLOURS.



Tortora.
Taupe.



Verde oliva.
Olive green.

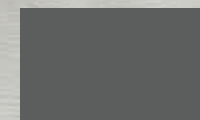

Antracite.
Anthracite.



Articolo LF6270

Tavolo quadrato in polipropilene pieghevole color tortora. Folding square table in polypropylene taupe color. cm. L. 60 P. 60 H. 74



Articolo LF6271

Tavolo quadrato in polipropilene pieghevole color antracite. Folding square table in polypropylene anthracite color. cm. L. 60 P. 60 H. 74



Articolo LF6272

Tavolo quadrato in polipropilene pieghevole color verde oliva. Folding square table in polypropylene olive green color. cm. L. 60 P. 60 H. 74

COLORI. COLOURS.



Tortora.
Taupe.



Verde oliva.
Olive green.



Antracite.
Anthracite.



Articolo LF6275

Tavolo rotondo in polipropilene pieghevole color tortora. Folding round table in polypropylene taupe color. cm. Ø. 60 H. 74



Articolo LF6276

Tavolo rotondo in polipropilene pieghevole color antracite. Folding round table in polypropylene anthracite color. cm. Ø. 60 H. 74



Articolo LF6277

Tavolo rotondo in polipropilene pieghevole color verde oliva. Folding round table in polypropylene olive green color. cm. Ø. 60 H. 74



COLORI. COLOURS.

Antracite.
Anthracite.

Tortora.
Taupe.

Durante la bella stagione sbocciano terrazze e giardini, fiori, colori e profumi pervadono nuovi spazi tutti da vivere. Con l'arredamento ZANINI outdoor design ogni ambiente diventa parte integrante della casa. Tante le proposte da scegliere, dai divanetti per il relax ai tavolini per piacevoli aperitivi all'aperto, passando per i complementi d'arredo che conferiscono un tocco di stile.

All'esterno come all'interno, desideriamo vivere con il massimo del comfort e della bellezza. Vi proponiamo soluzioni esteticamente accattivanti, realizzate con materiali in grado di resistere agli agenti atmosferici, trasformando il vostro giardino in un'altra stanza della casa. Crea la tua oasi di benessere, dove si fondono design, comfort e funzionalità.

During the summer, terraces and gardens bloom: flowers, colors and scents pervade new spaces to be experienced. With ZANINI outdoor design furniture, every room becomes an integral part of the home. There are many proposals to choose from, from sofas for relaxation to tables for pleasant aperitifs in the open air, passing through furnishing accessories that give a touch of style.

Outside as inside, we want to live with maximum comfort and beauty. We offer you aesthetically appealing solutions, made with materials that can withstand atmospheric agents, transforming your garden into another room in the house. Create your own wellness oasis, where design, comfort and functionality merge.

TAVOLI



Articolo LF6200

Tavolo in polipropilene
con fibra di vetro color antracite.
Polypropylene table
with fiber of glass anthracite color.
cm. L. 80 P. 80 H. 74



Articolo LF6211

Tavolo in polipropilene
con fibra di vetro color antracite.
Polypropylene table
with fiber of glass anthracite color.
cm. L. 60 P. 60 H. 75



Articolo LF6221

Tavolo in polipropilene
con fibra di vetro color antracite.
Polypropylene table
with fiber of glass anthracite color.
cm. L. 60 P. 60 H. 108



Articolo LF6220

Tavolo in polipropilene
con fibra di vetro color tortora.
Polypropylene table
with fiber of glass taupe color.
cm. L. 60 P. 60 H. 108



Articolo LF6210

Tavolo in polipropilene
con fibra di vetro color tortora.
Polypropylene table
with fiber of glass taupe color.
cm. L. 60 P. 60 H. 75



Articolo LF6201

Tavolo in polipropilene
con fibra di vetro color tortora.
Polypropylene table
with fiber of glass taupe color.
cm. L. 80 P. 80 H. 74

COLORI. COLOURS.



Antracite.
Anthracite.



Tortora.
Taupe.

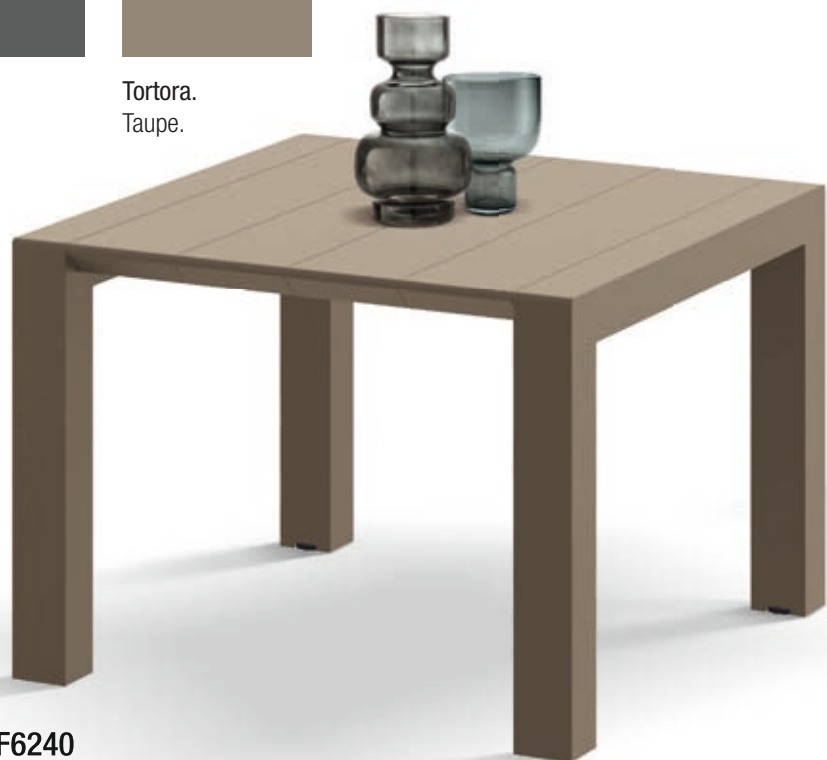

Articolo LF6240

Tavolo quadrato in polipropilene
colore tortora con 1 allunga da cm. 40.
Square table in polypropylene
taupe color with 1 extension of cm. 40.
cm. L. 100 P. 100 H. 75 aperto. open. 140 x 100



Articolo LF6241

Tavolo quadrato in polipropilene
colore antracite con 1 allunga da cm. 40.
Square table in polypropylene
anthracite color with 1 extension of cm. 40.
cm. L. 100 P. 100 H. 75 aperto. open. 140 x 100



Articolo LF6245

Tavolo rettangolare in polipropilene
colore tortora con 1 allunga da cm. 40.
Rectangular table in polypropylene
taupe color with 1 extension of cm. 40.
cm. L. 180 P. 100 H. 75 aperto. open. 220 x 100



TAVOLI PER USO INTERNO ED ESTERNO

Aggiungi alla tua terrazza o al tuo giardino un salotto moderno da esterno o una zona pranzo all'aperto e goditi bellissimi momenti estivi con i tuoi cari. Stare all'aperto diventa ancora più bello quando ci possiamo rilassare su un lettino o su una poltrona da giardino.

TABLE FOR INDOOR AND OUTDOOR USE

Add a modern outdoor lounge or outdoor dining area to your terrace or garden and enjoy beautiful summer moments with your loved ones. Being outdoors becomes even more beautiful when we can relax on a sun lounger or garden armchair.



Articolo LF6246

Tavolo rettangolare in polipropilene colore antracite con 1 allunga da cm. 40.
Rectangular table in polypropylene anthracite color with 1 extension of cm. 40.
cm. L. 180 P. 100 H. 75 aperto. open. 220 x 100



Articolo LF6251

Tavolo quadrato alto in polipropilene colore antracite con 1 allunga da cm. 40.
High square table in polypropylene anthracite color with 1 extension of cm. 40.
cm. L. 100 P. 100 H. 106 aperto. open. 140 x 100



COLORI. COLOURS.



Antracite.
Anthracite.



Tortora.
Taupe.



Articolo LF6550

Tavolo quadrato alluminio colore tortora.
Square table aluminum taupe color.
cm. L. 80 P. 80 H. 75



Articolo LF6551

Tavolo quadrato alluminio colore antracite.
Square table aluminum anthracite color.
cm. L. 80 P. 80 H. 75



Articolo LF6555

Tavolo rettangolare alluminio colore tortora.
Rectangular table aluminum taupe color.
cm. L. 140 P. 80 H. 75



Articolo LF6556

Tavolo rettangolare alluminio colore antracite.
Rectangular table aluminum anthracite color.
cm. L. 140 P. 80 H. 75

Articolo LF1700

Tavolo in metallo rotondo colore antracite.
Round metal table anthracite color.
cm. Ø. 70 H. 77



Articolo LF1701

Tavolo in metallo rotondo colore tortora.
Round metal table taupe color.
cm. Ø. 70 H. 77



COLORI. COLOURS.



Antracite.
Anthracite.



Tortora.
Taupe.



Articolo LF1706

Tavolo in metallo quadrato colore tortora.
Square metal table taupe color.
cm. L. 80 P. 80 H. 74



Articolo LF1705

Tavolo in metallo quadrato colore antracite.
Square metal table anthracite color.
cm. L. 80 P. 80 H. 74

TAVOLO IN METALLO USO INTERNO ED ESTERNO

Un tavolo che aggrazia gli spazi esterni della casa, assieme alle sedie correlate, immersi nel verde del proprio giardino e non solo. Infatti, il nostro tavolino dal design classico è ottimo anche per chi sta arredando il bar o ristorante all'aperto con distinzione ed eleganza.

METAL TABLE FOR INTERNAL AND EXTERNAL USE

A table that graces the outdoor spaces of the house, together with the related chairs, immersed in the greenery of its own garden and beyond. In fact, our classic design coffee table is also excellent for those who are furnishing the outdoor bar or restaurant with distinction and elegance.

COLORI. COLOURS.



Bianco.
White.



Fango.
Mud.



Antracite.
Anthracite



Articolo LF8022 ANTRACITE

Tavolo in metallo autolivellante colore antracite.
Self-leveling metal table anthracite color.
cm. L. 80 P. 80 H. 75



Articolo LF8022 BIANCO

Tavolo in metallo autolivellante colore bianco.
Self-leveling metal table white color.
cm. L. 80 P. 80 H. 75



Articolo LF8022 FANGO

Tavolo in metallo autolivellante colore fango.
Self-leveling metal table mud color.
cm. L. 80 P. 80 H. 75



Articolo LF8021 ANTRACITE
Tavolo in metallo autolivellante colore antracite.
Self-leveling metal table anthracite color.
cm. L. 70 P. 70 H. 75



Articolo LF8021 BIANCO
Tavolo in metallo autolivellante colore bianco.
Self-leveling metal table white color.
cm. L. 70 P. 70 H. 75



Articolo LF8021 FANGO
Tavolo in metallo autolivellante colore fango.
Self-leveling metal table mud color.
cm. L. 70 P. 70 H. 75



Articolo LF8025 ANTRACITE
Tavolo alto in metallo autolivellante colore antracite.
High self-leveling metal table anthracite color.
cm. L. 60 P. 60 H. 110



Articolo LF8025 BIANCO
Tavolo alto in metallo autolivellante colore bianco.
High self-leveling metal table white color.
cm. L. 60 P. 60 H. 110



Articolo LF8025 FANGO
Tavolo alto in metallo autolivellante colore fango.
High self-leveling metal table mood color.
cm. L. 60 P. 60 H. 110

Articolo LF8026 FANGO

Tavolo alto in metallo autolivellante colore fango.
High self-leveling metal table mud color.
cm. L. 70 P. 70 H. 110

Articolo LF8026 BIANCO

Tavolo alto in metallo autolivellante colore bianco.
High self-leveling metal table white color.
cm. L. 70 P. 70 H. 110

Articolo LF8026 ANTRACITE

Tavolo alto in metallo autolivellante colore antracite.
High self-leveling metal table anthracite color.
cm. L. 70 P. 70 H. 110

COLORI. COLOURS.

Bianco.
White.



Fango.
Mud.



Antracite.
Anthracite.

Articolo LF8014 ANTRACITE

Sgabello in metallo colore antracite.
Anthracite colored metal stool.
cm. L. 32 P. 32 H. 78

Articolo LF8014 FANGO

Sgabello in metallo colore fango.
Mud colored metal stool.
cm. L. 32 P. 32 H. 78

Articolo LF990

Tavolo quadrato in metallo colore antracite con foro centrale.
Square metal table anthracite color with central hole.
cm. L. 72 P. 72 H. 72

Articolo LF991

Tavolo quadrato in metallo colore bianco con foro centrale.
Square metal table white color with central hole.
cm. L. 72 P. 72 H. 72



Articolo LF5011

Tavolo rettangolare in polipropilene
intreccio antracite.

Rectangular table in anthracite
woven polypropylene.

cm. L. 150 P. 90 H. 74



Articolo LF5010

Tavolo quadrato in polipropilene
intreccio antracite.

Square table in anthracite
woven polypropylene.

cm. L. 80 P. 80 H. 74



Articolo LF745

Tavolo rettangolare piano vetro fumè
struttura in polipropilene trasparente.

Rectangular table with smoked glass top
transparent polypropylene structure.

cm. L. 120 P. 80 H. 76

ATHENAHOME&CONTRACT

**Articolo 300/GL**

Tavolo quadrato in legno spessore piano 25 mm.
gamba 5 x 5 ingombro base 58 x 58.
Square wooden table, top thickness 25 mm.
leg 5 x 5, base dimensions 58 x 58.
cm. L. 70 P. 70 H. 78

**Articolo 302/GL**

Tavolo quadrato alto in legno spessore piano 25 mm.
gamba 5 x 5 ingombro base 58 x 58.
High square wooden table, top thickness 25 mm.
leg 5 x 5, base dimensions 58 x 58.
cm. L. 70 P. 70 H. 110,5

**Articolo 301/GL**

Tavolo quadrato in legno spessore piano 25 mm.
gamba 5 x 5 ingombro base 68 x 68.
Square wooden table, top thickness 25 mm.
leg 5 x 5, base dimensions 68 x 68.
cm. L. 80 P. 80 H. 78



Foro porta allunghe disponibile solo per Art. 301/GL
Extension hole available only for Art. 301/GL



Articolo LF110 BIANCO

Tavolo in frassino laccato bianco.
White lacquered ash wood table.
cm. L. 77 P. 85 H. 78



Articolo LF603

Tavolo quadrato piano in MDF laccato bianco,
struttura in polipropilene e gambe in legno.
Square table with white lacquered MDF top,
polypropylene structure and wooden legs
cm. L. 80 P. 80 H. 73



Articolo LF600

Tavolo rotondo piano in MDF laccato bianco,
struttura in ferro e gambe in legno.
Round table with white lacquered MDF top,
iron structure and wooden legs.
cm. L. 80 P. 80 H. 74

**Articolo LF612**

Tavolo rettangolare piano in legno wengè
struttura in metallo canna di fucile.
Rectangular table in wenge wood top
gunmetal gray metal structure.
cm. L. 120 P. 80 H. 75

**Articolo LF607**

Tavolo rettangolare piano e struttura
in metallo canna di fucile.
Rectangular table gunmetal gray
metal top and structure.
cm. L. 120 P. 80 H. 75

**Articolo LF610**

Tavolo alto piano in legno wengè
struttura in metallo canna di fucile.
High table in wenge wood top
gunmetal gray metal structure.
cm. L. 60 P. 60 H. 105

**Articolo LF605**

Tavolo alto piano e struttura
in metallo canna di fucile.
High table gunmetal gray
metal top and structure.
cm. L. 60 P. 60 H. 105

**Articolo LF614**

Tavolo rettangolare piano in legno noce
struttura in metallo bianco anticato.
Rectangular table top in walnut wood
antique white metal structure.
cm. L. 120 P. 80 H. 75

CONTRACT

UN'ABITAZIONE RICAVATA DA UN AMBIENTE UNICO, Scopri sedie, poltrone, tavoli e complementi di design che si combinano con i mobili della tua sala da pranzo, soggiorno, cucina o terrazza. Trova l'opzione migliore per le tue stanze, scopri materiali, stili e colori esclusivi per differenziare la tua casa, trasformala in uno spazio comodo e piacevole per te e i tuoi ospiti. Sedie, tavoli e complementi di design ideale per la tua casa o il tuo spazio di lavoro, che si tratti di sedie in legno, sedie in plastica, metallo o sedie moderne a seconda del colore, come sedie gialle, sedie trasparenti, sedie nere, tra molte altre. Abbiamo anche sedie, poltrone, tavoli e complementi a seconda dello spazio in cui verranno collocate, dalle sedie da pranzo alle sedie da giardino. La nostra collezione offre una vasta gamma di mobili per soddisfare sia le impostazioni casual che quelle formali per la tua casa o lo spazio di lavoro.

A HOUSE OBTAINED FROM A UNIQUE ENVIRONMENT, Discover chairs, armchairs, tables and design accessories that combine with the furniture in your dining room, living room, kitchen or terrace. Find the best option for your rooms, discover exclusive materials, styles and colors to differentiate your home, transform it into a comfortable and pleasant space for you and your guests. Chairs, tables and design accessories ideal for your home or workspace, whether it's wooden chairs, plastic chairs, metal or modern chairs depending on the color, such as yellow chairs, transparent chairs, black chairs, among many others. We also have chairs, armchairs, tables and accessories depending on the space in which they will be placed, from dining chairs to garden chairs. Our collection offers a wide variety of furniture to suit both casual and formal settings for your home or workspace.





Articolo LF808

Basamento in metallo colore bianco 45x45
tubo metallo bianco 8x8 altezza fissa 72 cm.
piastra di fissaggio nero 30x30 peso 16 kg.
Basement in white metal 45x45
white metal tube 8x8 fixed height 72 cm.
black fixing plate 30x30 weight 16 kg.



Articolo LF807

Basamento doppio in metallo nero 70x45
tubi in metallo nero 8x8 altezza fissa 72 cm.
piastre di fissaggio 30x30 peso 24 kg.
Double basement in black metal 70x45
8x8 black metal tubes fixed height 72 cm.
fixing plates 30x30 weight 24 kg.



Articolo LF806 ALTO

Basamento in metallo nero 45x45
Tubo metallo nero 8x8 altezza fissa 105 cm.
Piastra di fissaggio 30x30 peso 16 kg.
Basement in black metal 42x42
black metal tube 8x8 fixed height 105 cm.
black fixing plate 30x30 weight 16 kg.

COLORI. COLOURS.

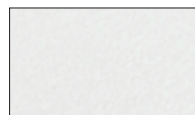

Metallo bianco.
White metal.



Metallo silver.
Silver metal.



Metallo nero.
Black metal.



Articolo LF806

Basamento in metallo nero 45x45
Tubo metallo nero 8x8 altezza fissa 72 cm.
Piastra di fissaggio 30x30 peso 16 kg.
Basement in black metal 42x42
black metal tube 8x8 fixed height 72 cm.
black fixing plate 30x30 weight 16 kg.



Articolo LF818

Basamento in resina con rivestimento
in metallo nero 40x40 tubo metallo nero 6x6
altezza fissa 72 cm. piastra fissaggio piano 25x25
in acciaio stampato peso 9 kg.
Basement in resin with black metal coating 40x40
black metal pipe 6x6 fixed height 72 cm.
pressed steel top fixing plate 25x25 weight 9 kg.

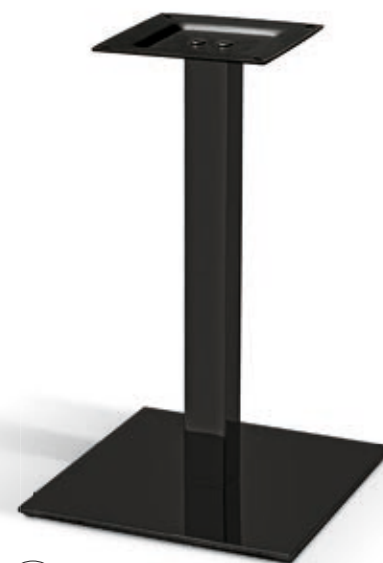

Articolo LF818 ESTERNO

Basamento in resina con rivestimento
in metallo nero 40x40 tubo metallo nero 6x6
altezza fissa 72 cm. piastra fissaggio piano 25x25
in acciaio stampato peso 9 kg.
Basement in resin with black metal coating 40x40
black metal pipe 6x6 fixed height 72 cm.
pressed steel top fixing plate 25x25 weight 9 kg.



Articolo LF809

Basamento in metallo silver 45x45
Tubo metallo silver 8x8 altezza fissa 72 cm.
Piastra di fissaggio a croce in ghisa 46x46 peso 19,5 kg.
Basement in silver metal 42x42
Silver metal tube 8x8 fixed height 72 cm.
Cross fixing plate in cast iron 46x46 weight 19.5 kg.



Articolo LF815

Basamento in resina con rivestimento in metallo silver 40x40
tubo metallo silver 6x6 altezza fissa 72 cm.
piastra fissaggio piano 25x25 in acciaio stampato peso 9 kg.
Basement in resin with silver metal coating 40x40
silver metal pipe 6x6 fixed height 72
pressed steel top fixing plate 25x25 Weight 9 kg.

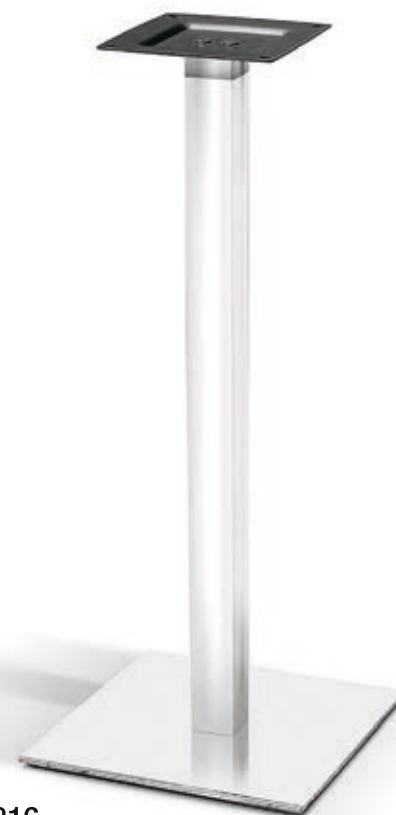

Articolo LF816

Basamento in resina con rivestimento in metallo silver 40x40
tubo metallo silver 6x6 altezza fissa 105 cm.
piastra fissaggio piano 25x25 in acciaio stampato peso 9 kg.
Basement in resin with silver metal coating 40x40
silver metal pipe 6x6 fixed height 105 cm.
pressed steel top fixing plate 25x25 Weight 9 kg.

COLORI. COLOURS.

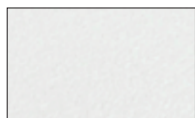

Metallo bianco.
White metal.



Metallo nero.
Black metal.



Articolo LF6561
Basamento in alluminio colore bianco.
Base in color white aluminum.
cm. L. 67 P. 45 H. 72



Articolo LF6560
Basamento in alluminio colore nero.
Base in color black aluminum.
cm. L. 67 P. 45 H. 72



Articolo LF6565
Basamento doppio in alluminio colore nero.
Double base in color black aluminum.
cm. L. 80 P. 45 H. 72



Articolo LF6566
Basamento doppio in alluminio colore bianco.
Double base in color white aluminum.
cm. L. 80 P. 45 H. 72

COLORI. COLOURS.

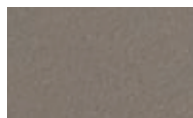

Metallo tortora.
Taupe metal.



Metallo antracite..
Anthracite metal.



Articolo LF828

Basamento in metallo colore antracite.
Ingombro 56x56 spessore gamba 4x2
piastra di fissaggio 30x30 altezza fissa 72 cm.
Anthracite color metal base.
Dimensions 56x56 leg thickness 4x2
fixing plate 30x30 fixed height 72 cm.



Articolo LF827

Basamento in metallo colore tortora.
Ingombro 56x56 spessore gamba 4x2
piastra di fissaggio 30x30 altezza fissa 72 cm.
Taupe color metal base.
Dimensions 56x56 leg thickness 4x2
fixing plate 30x30 fixed height 72 cm.

Particolare piastra per fissaggio piano.
Detail of the plate for fixing the top.



COLORI. COLOURS.

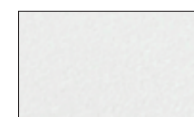

Metallo bianco.
White metal.



Metallo nero.
Black metal.



Articolo LF6231

Basamento pieghevole in polipropilene
con fibra di vetro colore bianco.
Folding polypropylene base
with fiber of glass white color.
cm. L. 47 P. 47 H. 71



Articolo LF6230

Basamento pieghevole in polipropilene
con fibra di vetro colore nero.
Folding polypropylene base
with fiber of glass black color.
cm. L. 47 P. 47 H. 71



**Articolo LF803**

Basamento ferro silver Ø. 50 cm.
 tubo ferro silver Ø. 7,6 cm. altezza fissa 72 cm.
 piastra di fissaggio a croce in ghisa 46x46 peso 14,5 kg.
 Silver iron basement Ø. 50 cm.
 silver iron pipe Ø. 7.6 cm. fixed height 72 cm.
 cross fixing plate in cast iron 46x46 weight 14.5 kg.

**Articolo LF804**

Basamento ferro silver Ø. 50 cm.
 tubo ferro silver Ø. 7,6 cm. altezza fissa 105 cm.
 piastra di fissaggio a croce in ghisa 46x46 peso 15 kg.
 Silver iron basement Ø. 50 cm.
 silver iron pipe Ø. 7.6 cm. fixed height 105 cm.
 cross fixing plate in cast iron 46x46 weight 15 kg.

**Articolo LF812**

Basamento in resina con rivestimento in metallo
 silver Ø. 40 cm. tubo ferro silver Ø. 6,3 cm.
 altezza fissa 72 cm. piastra fissaggio piano 25x25
 in acciaio stampato peso 7.5 kg.
 Basement in resin with metal coating
 silver Ø. 40 cm. silver iron pipe Ø. 6.3 cm.
 fixed height 72 cm. 25x25 top fixing plate
 in pressed steel weight 7.5 kg.

**Articolo LF821**

Basamento in resina con rivestimento in metallo
 nero Ø. 40 cm. tubo ferro nero Ø. 6,3 cm.
 Altezza fissa 72 cm. piastra fissaggio piano 25x25
 in acciaio stampato peso 8 kg.
 Basement in resin with metal coating
 black Ø. 40 cm. black iron pipe Ø. 6.3 cm.
 Fixed height 72 cm. 25x25 top fixing plate
 in pressed steel weight 8 kg.

**Articolo LF813**

Basamento in resina con rivestimento in metallo
 silver Ø. 40 cm. tubo ferro silver Ø. 6,3 cm.
 Altezza fissa 105 cm. piastra fissaggio piano 25x25
 in acciaio stampato peso 8 kg.
 Base in resin with silver metal coating
 Ø. 40 cm. silver iron pipe Ø. 6.3 cm.
 Fixed height 105 cm. 25x25 worktop fixing plate
 in pressed steel, weight 8 kg.

Articolo LF831
Basamento a tromba per tavolo colore bianco.
Trumpet basement for white color table.
cm. Ø. 70 H. 75



Articolo LF832
Basamento a tromba per tavolo colore nero.
Trumpet basement for black color table.
cm. Ø. 70 H. 75

Articolo LF829
Basamento in metallo per tavolo colore bianco.
Metal basement for black color table.
cm. L. 110 P. 67 H. 73



Articolo LF830
Basamento in metallo per tavolo colore nero.
Metal basement for black table.
cm. L. 110 P. 67 H. 73



Piano HPL colore bianco.
HPL white color top.

Articolo LF1502
cm. 69 x 69 Sp. 10

Articolo LF1552
cm. 80 x 80 Sp. 12



Piano HPL colore beige.
HPL beige color top.

Articolo LF1501
cm. 70 x 70 Sp. 12

Articolo LF1551
cm. 80 x 80 Sp. 12



Piano HPL colore antracite.
HPL anthracite color top.

Articolo LF1500
cm. 70 x 70 Sp. 12

Articolo LF1550
cm. 80 x 80 Sp. 12



Piano HPL colore rovere.
HPL oak wood color top.

Articolo LF1510
cm. 70 x 70 Sp. 12

Articolo LF1560
cm. 80 x 80 Sp. 12



Piano HPL colore corten.
HPL corten color top.

Articolo LF1511
cm. 69 x 69 Sp. 10

Articolo LF1561
cm. 79 x 79 Sp. 10

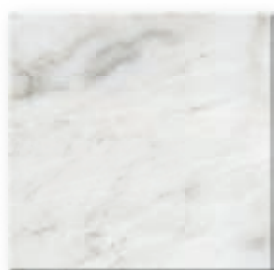

Piano HPL marmo bianco.
HPL white marble top.

Articolo LF840
cm. 79 x 79 Sp. 10

Articolo LF845
cm. 119 x 79 Sp. 10

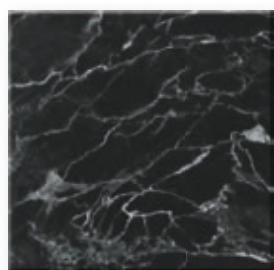

Piano HPL marmo nero.
HPL black marble top.

Articolo LF842
cm. 79 x 79 Sp. 10

Articolo LF846
cm. 119 x 79 Sp. 10

PIANI TAVOLI

Una collezione flessibile e customizzabile, sviluppata pensando alle sempre mutevoli esigenze del contract. Possibilità di materiali alternativi a vostra scelta e dimensioni personalizzate, potete abbinarli alle basi per tavoli di design e all'alta qualità dei materiali.

TABLE TOPS

A flexible and customizable collection, developed thinking of the ever-changing needs of the contract. Possibility of alternative materials of your choice and customized dimensions, you can combine them with the bases for design tables and the high quality of the materials.

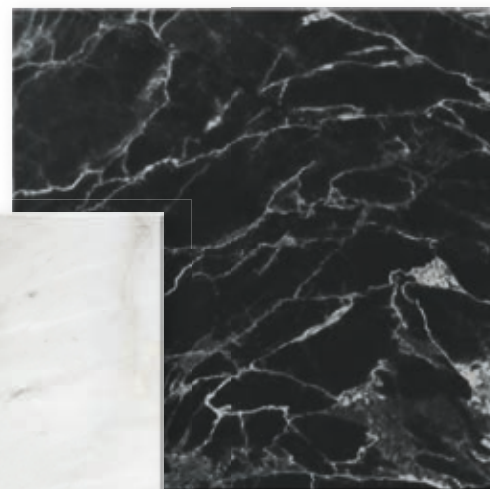

Articolo LF842
Piano marmo nero 79 x 79 cm.
Black marble top 79 x 79 cm.

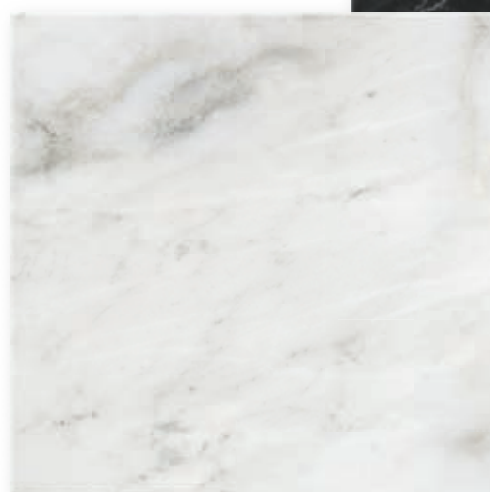

Articolo LF840
Piano marmo bianco 79 x 79 cm.
White marble top 79 x 79 cm.



Resistente alle bruciature.
Burn resistant.



Certificato LFGB. Conforme alle norme dell'alimentazione.
LFGB certificate. Compliant with alimentention standards.



Resistente al calore.
Heat resistant.



Resistente ai raggi UV.
UV resistant.



Uso interno ed esterno.
Indoor and outdoor use.





Articolo LF840
Piano HPL marmo bianco.
HPL white marble top.
cm. 79 x 79 Sp. 10

Articolo LF842
Piano HPL marmo nero.
HPL black marble top.
cm. 79 x 79 Sp. 10



Articolo LF1550
Piano HPL colore antracite.
HPL anthracite color top.
cm. 80 x 80 Sp. 12

Articolo LF1551
Piano HPL colore beige.
HPL beige color top.
cm. 80 x 80 Sp. 12

Articolo LF1552
Piano HPL colore bianco.
HPL white color top.
cm. 80 x 80 Sp. 12

Articolo LF1560
Piano HPL colore rovere.
HPL oak wood color top.
cm. 80 x 80 Sp. 12

Articolo LF1561
Piano HPL colore corten.
HPL corten color top.
cm. 79 x 79 Sp. 10

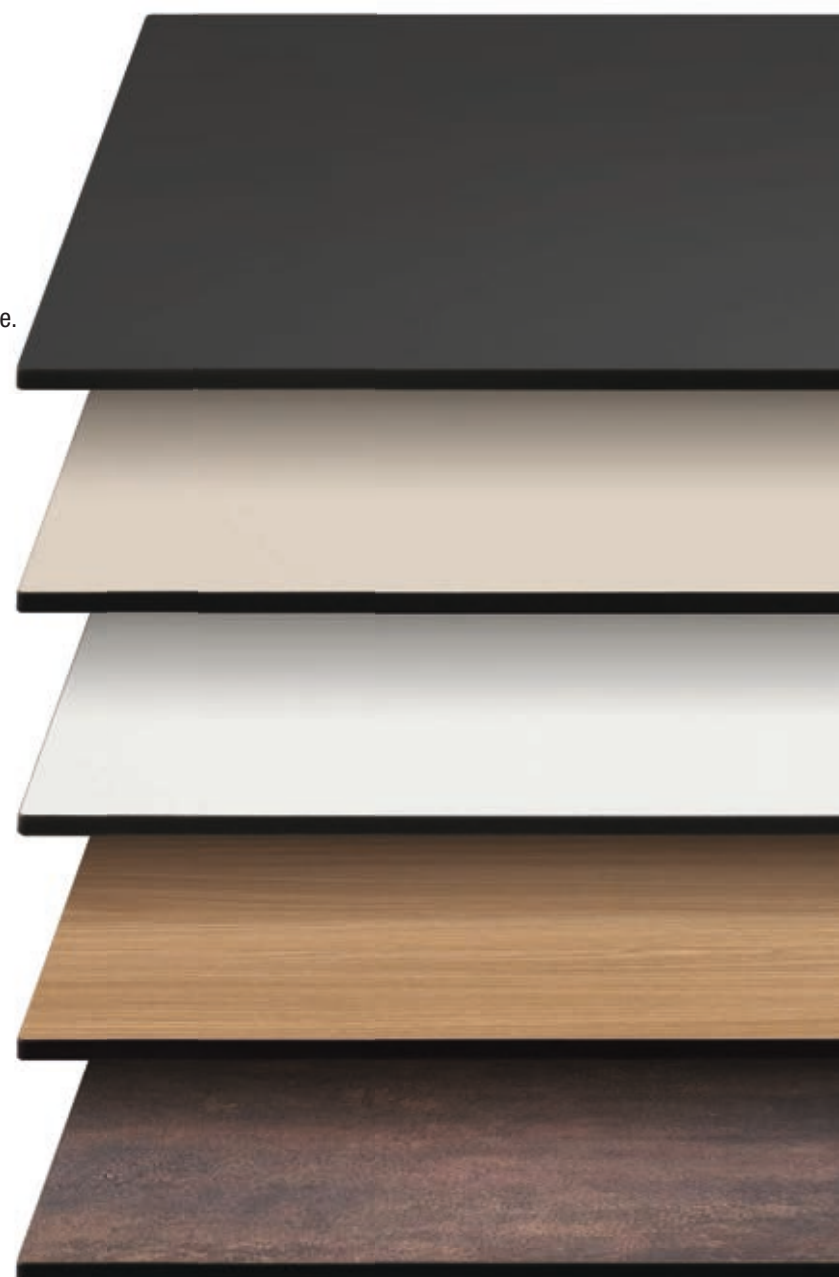

**Articolo LF1110**

Piano laminato rovere bordo ABS.
Oak laminate top ABS edge.
cm. 80 x 80 Sp. 25

Articolo LF1120

Piano laminato nero
bordo ABS ottone spazzolato.
Black laminate top
brushed brass ABS edge.
cm. 80 x 80 Sp. 25

Articolo LF1130

Piano laminato avorio
bordo ABS ottone spazzolato.
Ivory laminate top
brushed brass ABS edge.
cm. 80 x 80 Sp. 25

Articolo LF1140

Piano laminato marmo
nero bordo ABS ottone spazzolato.
Black marble laminate top
brushed brass ABS edge.
cm. 80 x 80 Sp. 25

Articolo LF1150

Piano laminato marmo bianco
bordo ABS ottone spazzolato.
White marble laminate top
brushed brass ABS edge.
cm. 80 x 80 Sp. 25

**Articolo LF1111**







Piano laminato rovere bordo ABS.
Oak laminate top ABS edge.
cm. 120 x 80 Sp. 25

Articolo LF1131

Piano laminato avorio
bordo ABS ottone spazzolato.
Ivory laminate top
brushed brass ABS edge.
cm. 120 x 80 Sp. 25





-  **Resistente alle bruciature.**
Burn resistant.
-  **Certificato LFGB. Conforme alle norme dell'alimentazione.**
LFGB certificate. Compliant with alimentation standards.
-  **Resistente al calore.**
Heat resistant.
-  **Resistente ai raggi UV.**
UV resistant.
-  **Usato interno ed esterno.**
Indoor and outdoor use.
-  **Superficie senza giunture.**
Seamless surface.
-  **Esclusiva superficie antigraffio.**
Exclusive scratch resistant surface.



SMART LINE

Articolo LF850
Piano bianco diametro 80 H. profilo 1,65 cm.
White top diameter 80 H. profile 1.65 cm.



Articolo LF860
Piano bianco 70 x 70 H. profilo 1,65 cm.
White top 70 x 70 H. profile 1.65 cm.



CLASSIC LINE

Articolo LF855
Piano bianco diametro 80 H. profilo 2,6 cm.
White top diameter 80 H. profile 2,6 cm.



SMART LINE

CLASSIC LINE

Articolo LF827

Basamento in metallo colore tortora.
Ingombro 56x56 spessore gamba 4x2
piastra di fissaggio 30x30 altezza fissa 72 cm.
Taupe color metal base.
Dimensions 56x56 leg thickness 4x2
fixing plate 30x30 fixed height 72 cm.



Particolare piastra per fissaggio piano.
Detail of the plate for fixing the top.



COLORI. COLOURS.

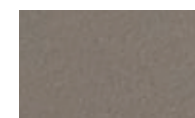

Metallo tortora.
Taupe metal.



Metallo antracite..
Anthracite metal.



Articolo LF828

Basamento in metallo colore antracite.
Ingombro 56x56 spessore gamba 4x2
piastra di fissaggio 30x30 altezza fissa 72 cm.
Anthracite color metal base.
Dimensions 56x56 leg thickness 4x2
fixing plate 30x30 fixed height 72 cm.

RELAX

UN'ABITAZIONE RICAVATA DA UN AMBIENTE UNICO, Scopri sedie, poltrone, tavoli e complementi di design che si combinano con i mobili della tua sala da pranzo, soggiorno, cucina o terrazza. Trova l'opzione migliore per le tue stanze, scopri materiali, stili e colori esclusivi per differenziare la tua casa, trasformala in uno spazio comodo e piacevole per te e i tuoi ospiti. Sedie, tavoli e complementi di design ideale per la tua casa o il tuo spazio di lavoro, che si tratti di sedie in legno, sedie in plastica, metallo o sedie moderne a seconda del colore, come sedie gialle, sedie trasparenti, sedie nere, tra molte altre. Abbiamo anche sedie, poltrone, tavoli e complementi a seconda dello spazio in cui verranno collocate, dalle sedie da pranzo alle sedie da giardino. La nostra collezione offre una vasta gamma di mobili per soddisfare sia le impostazioni casual che quelle formali per la tua casa o lo spazio di lavoro.

A HOUSE OBTAINED FROM A UNIQUE ENVIRONMENT, Discover chairs, armchairs, tables and design accessories that combine with the furniture in your dining room, living room, kitchen or terrace. Find the best option for your rooms, discover exclusive materials, styles and colors to differentiate your home, transform it into a comfortable and pleasant space for you and your guests. Chairs, tables and design accessories ideal for your home or workspace, whether it's wooden chairs, plastic chairs, metal or modern chairs depending on the color, such as yellow chairs, transparent chairs, black chairs, among many others. We also have chairs, armchairs, tables and accessories depending on the space in which they will be placed, from dining chairs to garden chairs. Our collection offers a wide variety of furniture to suit both casual and formal settings for your home or workspace.





Articolo LF2001

Poltrona imbottita tessuto grigio
reclinabile (Recliner elettrico con motore).
Armchair upholstered in gray fabric
reclining (Electric recliner with motor).
cm. L. 78 P. 96/158 H. 105 H.S. 50



Articolo LF2002

Poltrona imbottita tessuto blu
reclinabile (Recliner elettrico con motore).
Armchair upholstered in blue fabric
reclining (Electric recliner with motor).
cm. L. 78 P. 96/158 H. 105 H.S. 50



Articolo LF2000

Poltrona imbottita tessuto mattone
reclinabile (Recliner elettrico con motore).
Armchair upholstered in brick color fabric
reclining (Electric recliner with motor).
cm. L. 78 P. 96/158 H. 105 H.S. 50



Articolo LF2011
Poltrona girevole imbottita
tessuto grigio gambe in metallo.
Upholstered swivel armchair
gray fabric metal legs.
cm. L. 69 P. 89 H. 102 H.S. 48



Articolo LF2012
Poltrona girevole imbottita
tessuto blu notte gambe in metallo.
Upholstered swivel armchair
night blue fabric metal legs.
cm. L. 69 P. 89 H. 102 H.S. 48



Articolo LF2010
Poltrona girevole imbottita
tessuto beige gambe in metallo.
Upholstered swivel armchair
beige fabric metal legs.
cm. L. 69 P. 89 H. 102 H.S. 48



Articolo LF2056
Poltrona imbottita
tessuto grigio gambe in metallo.
Upholstered armchair
gray fabric metal legs.
cm. L. 81 P. 77 H. 82 H.S. 44



Articolo LF2055
Poltrona imbottita
tessuto arancione gambe in metallo.
Upholstered armchair
orange fabric metal legs.
cm. L. 81 P. 77 H. 82 H.S. 44





Articolo LF2020
Poltrona girevole imbottita
tessuto beige gambe in metallo.
Upholstered swivel armchair
beige fabric metal legs.
cm. L. 85 P. 83 H. 103 H.S. 42



Articolo LF2021
Poltrona girevole imbottita
tessuto grigio gambe in metallo.
Upholstered swivel armchair
gray fabric metal legs.
cm. L. 85 P. 83 H. 103 H.S. 42



Articolo LF2025
Poltrona girevole imbottita
tessuto arancione gambe in metallo.
Upholstered swivel armchair
orange fabric metal legs.
cm. L. 81 P. 85 H. 99 H.S. 44



Articolo LF2026
Poltrona girevole imbottita
tessuto grigio gambe in metallo.
Upholstered swivel armchair
gray fabric metal legs.
cm. L. 81 P. 85 H. 99 H.S. 44



Articolo LF2030
Poltrona imbottita tessuto
beige gambe in metallo.
Upholstered armchair
beige fabric metal legs.
cm. L. 83 P. 89 H. 109 H.S. 44



Articolo LF2031
Poltrona imbottita tessuto
grigio gambe in metallo.
Upholstered armchair
gray fabric metal legs.
cm. L. 83 P. 89 H. 109 H.S. 44



Articolo LF2050
Poltrona imbottita tessuto
arancione gambe in metallo.
Upholstered armchair
orange fabric metal legs.
cm. L. 81 P. 70 H. 85 H.S. 44



Articolo LF2051
Poltrona imbottita tessuto
blu gambe in metallo.
Upholstered armchair
blue fabric metal legs.
cm. L. 81 P. 70 H. 85 H.S. 44



Articolo LF2040
Poltrona girevole imbottita
tessuto beige gambe in metallo.
Upholstered swivel armchair
beige fabric metal legs.
cm. L. 75 P. 90 H. 87 H.S. 43



Articolo LF2041
Poltrona girevole imbottita
tessuto grigio gambe in metallo.
Upholstered swivel armchair
gray fabric metal legs.
cm. L. 75 P. 90 H. 87 H.S. 43



Articolo LF2043
Poltrona girevole imbottita
tessuto blu gambe in metallo.
Upholstered swivel armchair
blue fabric metal legs.
cm. L. 75 P. 90 H. 87 H.S. 43



Articolo LF2042
Poltrona girevole imbottita
tessuto verde scuro gambe in metallo.
Upholstered swivel armchair
dark green fabric metal legs.
cm. L. 75 P. 90 H. 87 H.S. 43

Articolo LF720

Poltrona imbottita in denim slavato.
Upholstered armchair in washed denim.
cm. L. 140 P. 72 H. 73



Articolo LF712

Cuscino imbottito in denim slavato.
Upholstered cushion in washed denim.
cm. L. 44 P. 44 H. 15



Articolo LF716

Pouf imbottito in denim slavato.
Upholstered pouf in washed denim.
cm. L. 85 P. 80 H. 45



Articolo LF705

Pouf imbottito in denim slavato.
Upholstered pouf in washed denim.
cm. L. 53 P. 38 H. 28





Articolo LF700
Poltrona imbottita in denim slavato.
Upholstered armchair in washed denim.
cm. L. 130 P. 82 H. 65



Articolo LF701
Poltrona imbottita in similpelle marrone.
Upholstered armchair in brown leatherette.
cm. L. 130 P. 82 H. 65



Articolo LF731
 Poltrona imbottita in similpelle marrone.
 Upholstered armchair in brown leatherette.
 cm. L. 80 P. 78 H. 57



Articolo LF717
 Pouf imbottito in similpelle marrone.
 Upholstered pouf in brown leatherette.
 cm. L. 85 P. 80 H. 45



Articolo LF721
 Poltrona imbottito in similpelle marrone.
 Upholstered armchair in brown leatherette.
 cm. L. 140 P. 72 H. 73



Articolo LF713
 Cuscino imbottito in similpelle marrone.
 Upholstered cushion in brown leatherette.
 cm. L. 44 P. 44 H. 15

**Articolo LF493**

Poltrona imbottita in tessuto blu.
Upholstered armchair in blue fabric.
cm. L. 68 P. 70 H. 96 H.S. 39

Sgabello imbottito in tessuto blu.
Upholstered stool in blue fabric.
cm. L. 65 P. 44 H. 53 H.S. 43

130**Articolo LF743**

Pouf imbottito in similpelle grigio.
Upholstered pouf in gray leatherette.
cm. L. 40 P. 40 H. 40

COMPLEMENTI

UN'ABITAZIONE RICAVATA DA UN AMBIENTE UNICO, Scopri sedie, poltrone, tavoli e complementi di design che si combinano con i mobili della tua sala da pranzo, soggiorno, cucina o terrazza. Trova l'opzione migliore per le tue stanze, scopri materiali, stili e colori esclusivi per differenziare la tua casa, trasformala in uno spazio comodo e piacevole per te e i tuoi ospiti. Sedie, tavoli e complementi di design ideale per la tua casa o il tuo spazio di lavoro, che si tratti di sedie in legno, sedie in plastica, metallo o sedie moderne a seconda del colore, come sedie gialle, sedie trasparenti, sedie nere, tra molte altre. Abbiamo anche sedie, poltrone, tavoli e complementi a seconda dello spazio in cui verranno collocate, dalle sedie da pranzo alle sedie da giardino. La nostra collezione offre una vasta gamma di mobili per soddisfare sia le impostazioni casual che quelle formali per la tua casa o lo spazio di lavoro.

A HOUSE OBTAINED FROM A UNIQUE ENVIRONMENT, Discover chairs, armchairs, tables and design accessories that combine with the furniture in your dining room, living room, kitchen or terrace. Find the best option for your rooms, discover exclusive materials, styles and colors to differentiate your home, transform it into a comfortable and pleasant space for you and your guests. Chairs, tables and design accessories ideal for your home or workspace, whether it's wooden chairs, plastic chairs, metal or modern chairs depending on the color, such as yellow chairs, transparent chairs, black chairs, among many others. We also have chairs, armchairs, tables and accessories depending on the space in which they will be placed, from dining chairs to garden chairs. Our collection offers a wide variety of furniture to suit both casual and formal settings for your home or workspace.





Articolo LF1607
Lampada in metallo colore nero lucido.
Lamp in glossy black metal color.
cm. L. 23 P. 23 H. 38



Articolo LF1600
Lampada alta in metallo colore nero lucido.
Tall lamp in glossy black metal color.
cm. L. 36 P. 36 H. 153



Articolo LF1620
Tavolino in metallo colore nero lucido con bordo oro. Coffee table in glossy black metal with gold edge.
cm. Ø. 60 H. 55



Articolo LF1621
Tavolino in metallo colore beige lucido con bordo oro. Coffee table in glossy beige metal with gold edge.
cm. Ø. 51 H. 48



Articolo LF1622
Tavolino in metallo colore verdino lucido con bordo oro. Coffee table in glossy greenish metal with gold edge.
cm. Ø. 36 H. 45



Articolo LF1608
Lampada in metallo colore grigio.
Lamp in gray metal color.
cm. Ø. 20 H. 31



Articolo LF1605
Lampada in metallo colore rosa.
Tall lamp in pink metal color.
cm. Ø. 36 H. 45



Articolo LF1606
Lampada in metallo colore verde.
Tall lamp in green metal color.
cm. Ø. 32 H. 38



Articolo LF1609
Lampada in metallo colore verde.
Lamp in green metal color.
cm. Ø. 26 H. 37



Articolo LF1610
Lampada in metallo colore tortora.
Lamp in taupe metal color.
cm. Ø. 31 H. 44



COLORI. COLOURS.



Beige.
Beige.



Verde.
Green.



Nero.
Black.



Articolo LF1625
Tavolino in metallo colore nero.
Coffee table in black metal color.
cm. Ø. 46 H. 50



Articolo LF1626
Tavolino in metallo colore verde.
Coffee table in green metal color.
cm. Ø. 39 H. 44



Articolo LF1627
Tavolino in metallo colore beige.
Coffee table in beige metal color.
cm. Ø. 36 H. 41



COLORI. COLOURS.



Verde.
Green.



Marrone.
Brown.



Articolo LF1631
Tavolino in metallo dorato.
Coffee table in golden metal color.
cm. Ø. 40 H. 47



Articolo LF1623
Tavolino in metallo colore verde.
Coffee table in green metal color.
cm. Ø. 40 H. 53



Articolo LF1624
Tavolino in metallo colore marrone.
Coffee table in brown metal color.
cm. Ø. 39 H. 44





COLORI. COLOURS.

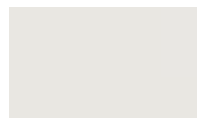

Bianco.
White.



Beige.
beige.



Verde.
Green.



Articolo LF1628
Tavolino in metallo colore bianco.
Coffee table in white metal color.
cm. Ø. 52 H. 43



Articolo LF1629
Tavolino in metallo colore beige.
Coffee table in beige metal color.
cm. Ø. 40 H. 40



Articolo LF1630
tavolino in metallo colore verde.
Coffee table in green metal color.
cm. Ø. 31 H. 36





COLORI. COLOURS.



Tortora.
Taupe.



Verde oliva.
Olive green.



Antracite.
Anthracite.



Articolo LF6260

Tavolino rettangolare in polipropilene con fibra di vetro colore tortora.
Polypropylene rectangular coffee table with fiber of glass taupe color.
cm. L. 90 P. 50 H. 40



Articolo LF6261

Tavolino rettangolare in polipropilene con fibra di vetro colore antracite.
Polypropylene rectangular coffee table with fiber of glass anthracite color.
cm. L. 90 P. 50 H. 40



Articolo LF6262

Tavolino rettangolare in polipropilene con fibra di vetro colore verde oliva.
Polypropylene rectangular coffee table with fiber of glass olive green color.
cm. L. 90 P. 50 H. 40



Articolo LF6265

Tavolino quadrato in polipropilene con fibra di vetro colore tortora.
Polypropylene square coffee table with fiber of glass taupe color.
cm. L. 41 P. 42 H. 40



Articolo LF6266

Tavolino quadrato in polipropilene con fibra di vetro colore antracite.
Polypropylene square coffee table with fiber of glass anthracite color.
cm. L. 41 P. 42 H. 40



Articolo LF6267

Tavolino quadrato in polipropilene con fibra di vetro colore verde oliva.
Polypropylene square coffee table with fiber of glass olive green color.
cm. L. 41 P. 42 H. 40



Articolo LF764

Tavolino rettangolare portaoggetti piano MDF laccato bianco gambe in metallo nero.
Rectangular storage table with white lacquered MDF top and black metal legs.
cm. L. 100 P. 50 H. 43,5



Articolo LF763

Tavolino quadrato portaoggetti piano MDF laccato bianco gambe in metallo nero.
Square storage table with white lacquered MDF top and black metal legs.
cm. L. 51 P. 51 H. 43,5



COLORI. COLOURS.



Bianco.
White.



Grigio.
Gray.



Nero.
Black.



Articolo LF834

Tavolino rettangolare in legno laccato bianco con ripiano in paglia di Vienna.
Rectangular coffee table in white lacquered wood with Vienna straw shelf.
cm. L. 100 P. 50 H. 43



Articolo LF836

Tavolino quadrato in legno laccato bianco con ripiano in paglia di Vienna.
Square coffee table in white lacquered wood with Vienna straw shelf.
cm. L. 60 P. 60 H. 43



Articolo LF838

Tavolino rettangolare in legno laccato nero con ripiano in paglia di Vienna.
Rectangular coffee table in black lacquered wood with Vienna straw shelf.
cm. L. 100 P. 50 H. 43



Articolo LF839

Tavolino quadrato in legno laccato nero con ripiano in paglia di Vienna.
Square coffee table in black lacquered wood with Vienna straw shelf.
cm. L. 60 P. 60 H. 43



Articolo LF835

Tavolino rettangolare in legno laccato grigio con ripiano in paglia di Vienna.
Rectangular coffee table in gray lacquered wood with Vienna straw shelf.
cm. L. 100 P. 50 H. 43



Articolo LF837

Tavolino quadrato in legno laccato grigio con ripiano in paglia di Vienna.
Square coffee table in gray lacquered wood with Vienna straw shelf.
cm. L. 60 P. 60 H. 43



COLORI. COLOURS.

POUF USO INTERNO E ESTERNO

Le nostre soluzioni di arredamento parlano di qualità della vita, ispirano una scelta: quella di vivere meglio, in naturale sintonia con i nostri spazi. Ogni aspetto della produzione garantisce funzionalità, affidabilità nel tempo e resistenza agli effetti atmosferici. Tante proposte interessanti, ideali per qualsiasi esigenza sia di spazio che di condizioni climatiche.

POUF FOR INDOOR AND OUTDOOR USE

Our furnishing solutions speak of quality of life, they inspire a choice: that of living better, in natural harmony with our spaces. Every aspect of production guarantees functionality, reliability over time and resistance to atmospheric effects. Many interesting proposals, ideal for any need both in terms of space and climatic conditions.



Avorio.
Ivory.



Nero.
Black.



Articolo LF1650

Set tavolini in metallo colore avorio.
Set of ivory metal coffee tables.
cm. Ø. 69 H. 41 cm. Ø. 49 H. 49



Articolo LF1651

Set tavolini in metallo color nero.
Set of black metal coffee tables.
cm. Ø. 69 H. 41 cm. Ø. 49 H. 49





Articolo LF888
Tavolino in polipropilene color grigio.
Gray polypropylene small table.
cm. Ø. 70 H. 36



Articolo LF885
Tavolino in polipropilene color bianco.
White polypropylene small table.
cm. Ø. 70 H. 36



Articolo LF859
Tavolino in polipropilene color Nero.
Black polypropylene small table.
cm. Ø. 70 H. 36



Articolo LF886
Tavolino in polipropilene color verde.
Green polypropylene small table.
cm. Ø. 70 H. 36



Articolo LF887
Tavolino in polipropilene color rosa.
Pink polypropylene small table.
cm. Ø. 70 H. 36

POUF USO INTERNO E ESTERNO

Le nostre soluzioni di arredamento parlano di qualità della vita, ispirano una scelta: quella di vivere meglio, in naturale sintonia con i nostri spazi. Ogni aspetto della produzione garantisce funzionalità, affidabilità nel tempo e resistenza agli effetti atmosferici. Tante proposte interessanti, ideali per qualsiasi esigenza sia di spazio che di condizioni climatiche.

POUF FOR INDOOR AND OUTDOOR USE

Our furnishing solutions speak of quality of life, they inspire a choice: that of living better, in natural harmony with our spaces. Every aspect of production guarantees functionality, reliability over time and resistance to atmospheric effects. Many interesting proposals, ideal for any need both in terms of space and climatic conditions.

COLORI. COLOURS.



Nero.
Black.

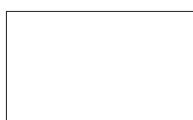

Bianco.
White.



Verde.
Green.



Rosa.
Pink.



Grigio.
Gray.



Giallo.
Yellow.



Articolo LF865

Tavolino in polipropilene color bianco.
White polypropylene small table.
cm. Ø. 50 H. 46



Articolo LF858

Tavolino in polipropilene color nero.
Black polypropylene small table.
cm. Ø. 50 H. 46



Articolo LF868

Tavolino in polipropilene color grigio.
Gray polypropylene small table.
cm. Ø. 50 H. 46



Articolo LF866

Tavolino in polipropilene color verde.
Green polypropylene small table.
cm. Ø. 50 H. 46



Articolo LF867

Tavolino in polipropilene color rosa.
Pink polypropylene small table.
cm. Ø. 50 H. 46



Articolo LF869

Tavolino in polipropilene color giallo.
Yellow polypropylene small table.
cm. Ø. 50 H. 46





Articolo **LF873**
Tavolino rettangolare in vetro temperato.
Rectangular coffee table in tempered glass.
cm. L. 115 P. 60 H. 35,5



Articolo **LF879**
Tavolino rettangolare in vetro temperato.
Rectangular coffee table in tempered glass.
cm. L. 120 P. 40 H. 45



Articolo **LF881**
Tavolino rettangolare con ripiano
in vetro temperato. Rectangular coffee table
with shelf in tempered glass.
cm. L. 110 P. 40 H. 38 H.R.17



Articolo **LF875**
Consolle con ripiano in vetro temperato.
Console with shelf in tempered glass.
cm. L. 126 P. 40 H. 75 H.R.56





Articolo **LF874**
Tavolino portariviste in vetro temperato.
Magazine rack coffee table in tempered glass.
cm. L. 61 P. 42 H. 36,5



Articolo **LF877**
Tavolino in vetro temperato.
Coffee table in tempered glass.
cm. L. 50 P. 49 H. 58



Articolo **LF876**
Scrivania in vetro temperato.
Writing desk in tempered glass.
cm. L. 125 P. 70 H. 77

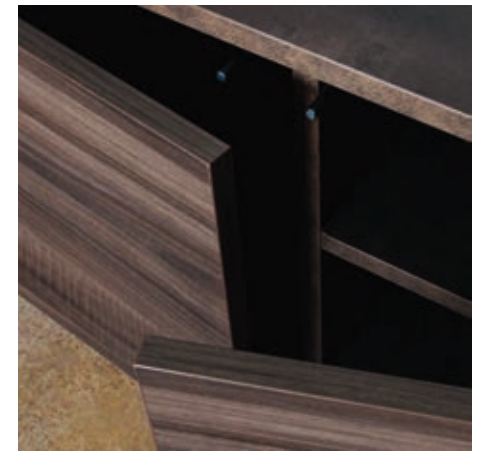

Particolare apertura ante push e pull.
Detail of push and pull doors opening.

Articolo **LF1029**
Madia 3 ante struttura melaminico effetto
corten ante melaminico noce canaletto
basamento metallo colore ottone H. 30 cm.
3 doors sideboard corten effect melamine
structure canaletto walnut melamine doors
brass color metal base H. 30 cm.
cm. L. 180 P. 45 H. 80



Articolo **LF1028**
Porta TV 3 ante struttura melaminico effetto
corten ante melaminico noce canaletto
basamento metallo colore ottone H. 30 cm.
3 doors TV stand corten effect melamine
structure canaletto walnut melamine doors
brass color metal base H. 30 cm.
cm. L. 180 P. 45 H. 70



Articolo LF1005

Madia 2 ante struttura melaminico nero ante melaminico nero basamento metallo colore nero H. 31 cm. 2 doors sideboard in black melamine structure black melamine doors black metal basement H. 31 cm. cm. L. 180 P. 45 H. 80



Articolo LF1004

Porta TV 2 ante struttura melaminico nero ante melaminico nero basamento metallo colore nero H. 31 cm. 2 doors TV stand in black melamine structure black melamine doors black metal basement H. 31 cm. cm. L. 180 P. 45 H. 70



Articolo LF1046

Porta TV 2 ante struttura melaminico effetto olmo ante melaminico olmo basamento metallo colore bianco H. 31 cm. 2 doors TV stand melamine structure elm wood effect melamine doors elm wood basement white metal H. 31 cm. cm. L. 180 P. 45 H. 70



Articolo LF1047

Madia 2 ante struttura melaminico effetto olmo ante melaminico olmo basamento metallo colore bianco H. 31 cm. 2 doors sideboard melamine structure elm wood effect melamine doors elm wood basement white metal H. 31 cm. cm. L. 180 P. 45 H. 80



Articolo **LF306 GL NAT**
 Credenza in MDF laccata bianca
 con ante scorrevoli in rovere naturale.
 MDF sideboard in white lacquered
 with sliding doors in natural oak.
 cm. L. 185,5 P. 50 H. 78



Articolo **LF311 GL NAT**
 Porta TV in MDF laccata bianca
 con ante scorrevoli in rovere naturale.
 MDF Tv stand in white lacquered
 with sliding doors in natural oak.
 cm. L. 185,5 P. 50 H. 44,5



Articolo **LF400 MIELE**
 Credenza in frassino 2 porte colore miele.
 2 doors ash wood sideboard honey color.
 cm. L. 112 P. 44 H. 88



Articolo **LF400 CENERE**
 Credenza in frassino 2 porte colore cenere.
 2 doors ash wood sideboard ash color.
 cm. L. 112 P. 44 H. 88



Articolo LF401 CENERE

Credenza in frassino 2 porte 2 cassetti colore cenere.
2 doors ash wood sideboard 2 drawers ash color.
cm. L. 126 P. 48 H. 90

Articolo LF401 BIANCO
Credenza in frassino 2 porte
2 cassetti colore bianco. 2 doors ash wood
sideboard 2 drawers white color.
cm. L. 126 P. 48 H. 90



Articolo LF404 BIANCO
Credenza in frassino 1 porta
3 cassetti con vani colore bianco.
1 door ash wood sideboard 3 drawers
with compartments white color.
cm. L. 152 P. 48 H. 82



Articolo LF404 MIELE

Credenza in frassino 1 porta
3 cassetti con vani colore miele.
1 door ash wood sideboard 3 drawers
with compartments honey color.
cm. L. 152 P. 48 H. 82

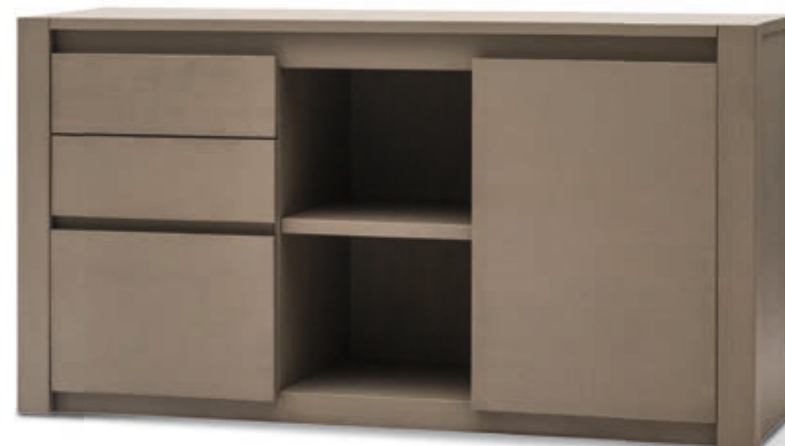

Articolo LF404 CENERE
Credenza in frassino 1 porta
3 cassetti con vani colore cenere.
1 door ash wood sideboard 3 drawers
with compartments ash color.
cm. L. 152 P. 48 H. 82



Articolo **LF405 BIANCO**

Porta TV in frassino 2 porte
1 cassetto con vano colore bianco.
2 doors ash wood sideboard 1 drawer
with compartments white color.
cm. L. 144 P. 48 H. 44



Articolo **LF405 MIELE**

Porta TV in frassino 2 porte
1 cassetto con vano colore miele.
2 doors ash wood sideboard 1 drawer
with compartments honey color.
cm. L. 144 P. 48 H. 44



Articolo **LF405 CENERE**

Porta TV in frassino 2 porte
1 cassetto con vano colore cenere.
2 doors ash wood sideboard 1 drawer
with compartments ash color.
cm. L. 144 P. 48 H. 44

OUTDOORS

UN'ABITAZIONE RICAVATA DA UN AMBIENTE UNICO, Scopri sedie, poltrone, tavoli e complementi di design che si combinano con i mobili della tua sala da pranzo, soggiorno, cucina o terrazza. Trova l'opzione migliore per le tue stanze, scopri materiali, stili e colori esclusivi per differenziare la tua casa, trasformala in uno spazio comodo e piacevole per te e i tuoi ospiti. Sedie, tavoli e complementi di design ideale per la tua casa o il tuo spazio di lavoro, che si tratti di sedie in legno, sedie in plastica, metallo o sedie moderne a seconda del colore, come sedie gialle, sedie trasparenti, sedie nere, tra molte altre. Abbiamo anche sedie, poltrone, tavoli e complementi a seconda dello spazio in cui verranno collocate, dalle sedie da pranzo alle sedie da giardino. La nostra collezione offre una vasta gamma di mobili per soddisfare sia le impostazioni casual che quelle formali per la tua casa o lo spazio di lavoro.

A HOUSE OBTAINED FROM A UNIQUE ENVIRONMENT, Discover chairs, armchairs, tables and design accessories that combine with the furniture in your dining room, living room, kitchen or terrace. Find the best option for your rooms, discover exclusive materials, styles and colors to differentiate your home, transform it into a comfortable and pleasant space for you and your guests. Chairs, tables and design accessories ideal for your home or workspace, whether it's wooden chairs, plastic chairs, metal or modern chairs depending on the color, such as yellow chairs, transparent chairs, black chairs, among many others. We also have chairs, armchairs, tables and accessories depending on the space in which they will be placed, from dining chairs to garden chairs. Our collection offers a wide variety of furniture to suit both casual and formal settings for your home or workspace.



DIVANETTO E POLTRONA PER USO INTERNO ED ESTERNO

Caratterizzati da un design estremamente moderno, il divanetto e la poltrona sono dotati di seduta e schienale in resina forata. Questo dettaglio la rende particolarmente leggera e raffinata e allo stesso tempo flessibile e confortevole per accogliere l'ospite. Su richiesta, è possibile anche adattare sedute in colori differenti, rendendo il divanetto e la poltrona versatili e funzionali adatti a qualsiasi esigenza di arredo.

SOFA AND ARMCHAIR FOR INDOOR AND OUTDOOR USE

Characterized by an extremely modern design, the sofa and armchair are equipped with seat and back in perforated resin. This detail makes it particularly light and refined and at the same time flexible and comfortable to accommodate the guest. On request, it is also possible to adapt seats in different colors, making the sofa and armchair versatile and functional suitable for any furnishing need.

COLORI. COLOURS.



Antracite.
Anthracite



Articolo LF6171
Poltrona in polipropilene effetto rattan color antracite con cuscino.
Polypropylene rattan effect armchair in anthracite color with pillow.
cm. L. 72 P. 76 H. 89 H.S. 43



Articolo LF6170
Divanetto in polipropilene effetto rattan color antracite con cuscino.
Polypropylene rattan effect small sofa in anthracite color with pillow.
cm. L. 128 P. 77 H. 89 H.S. 43



Articolo LF6173
Tavolino in polipropilene effetto rattan color antracite.
Polypropylene rattan effect coffee table in anthracite color.
cm. L. 45 P. 45 H. 45



Articolo LF6172
Tavolino in polipropilene effetto rattan color antracite.
Polypropylene rattan effect coffee table in anthracite color.
cm. L. 92 P. 53 H. 45





UNA SCELTA VINCENTE PER LO SPAZIO OUTDOOR

Finalmente si torna a vivere dopo il lungo, durissimo inverno appena trascorso.

Sia il clima mite e l'estate appena iniziata, sia le necessarie disposizioni anticontagio, consigliano di vivere al massimo negli spazi esterni.

Attrezzare il proprio terrazzo, giardino o balcone spazioso con un salotto esterno è dunque la scelta vincente per intrattenere gli ospiti in un'atmosfera informale e rilassata organizzando cene o più semplicemente pomeriggi e serate in compagnia.

A WINNING CHOICE FOR THE OUTDOOR SPACE

Finally we are back to life after the long, very hard winter that has just passed.

Both the mild climate and the summer that has just begun, and the necessary anti-contagion provisions, recommend that you live to the fullest in outdoor spaces. Equipping your terrace, garden or spacious balcony with an outdoor lounge is therefore the winning choice to

entertain guests in an informal and relaxed atmosphere by organizing dinners or simply afternoons and evenings with friends.



Articolo LF6111

Divanetto polipropilene color antracite.

Polypropylene small sofa in anthracite color.

cm. L. 138 P. 62 H. 80 H.S. 43



COLORI. COLOURS.



Articolo LF6510

Poltrona polipropilene color beige.

Polypropylene armchair in beige color.

cm. L. 57 P. 58 H. 82 H.S. 45

Beige.

Beige.

COLORI. COLOURS.



Grigio.

Gray.



Articolo LF6112

Tavolino polipropilene color antracite.

Polypropylene coffee table in anthracite color.

cm. L. 70 P. 50 H. 43



Articolo LF6110

Poltrona polipropilene color antracite.

Polypropylene armchair in anthracite color.

cm. L. 65 P. 58 H. 80 H.S. 44



CAFE

CAFE MENU

American	2.80
Espresso	2.10
Latte	3.10
Vanilla Latte	3.75
Macchiato	3.00
Mocha	3.99
Chocolate	3.50

Articolo LF6160

KIT Salottino in polipropilene con fibra di vetro colore grigio azzurro composto da:
2 poltrone, 1 divanetto **completi di cuscini** e 1 tavolino.

Modern lounge kit in polypropylene with fiber glass blue gray color composed of:
2 armchairs, 1 sofa complete with pillows and 1 coffee table.



Divanetto in polipropilene con fibra di vetro e cuscini.

Polypropylene sofa with glass fibre and cushions.

cm. L. 138 P. 72 H. 83 H.S. 46



Poltrona in polipropilene con fibra di vetro e cuscini.

Polypropylene armchair with glass fibre and cushions.

cm. L. 73 P. 72 H. 83 H.S. 46



Tavolino quadrato in polipropilene con fibra di vetro.

Polypropylene square coffee table with glass fibre

cm. L. 65 P. 65 H. 33



COLORI. COLOURS.



Grigio azzurro.
Blue gray.



Tortora.
Taupe.

Con stile lineare ed elegante questo salotto è l'ideale per trascorrere momenti di relax con amici e famiglia all'aria aperta.

Il salotto è composto da due ampie poltrone, un divano a due posti ed un tavolino basso, che offrirà un ottimo sostegno per cibi e bevande o per un buon libro. Questo salotto da giardino è robusto e resistente, adatto per resistere alle intemperie ed ai raggi UV. Il cuscini delle sedute ci darà una resa estetica e tattile come il tessuto, unita ad una praticità di pulizia come i tessuti lavabili.

With a linear and elegant style, this living room is ideal for spending relaxing moments with friends and family in the open air.

The living room consists of two large armchairs, a two-seater sofa and a low table, which will offer excellent support for food and drinks or for a good book. This garden lounge is robust and resistant, suitable to withstand bad weather and UV rays. The seat cushions will give us an aesthetic and tactile result like the fabric, combined with a practicality of cleaning like washable fabrics.



Articolo LF6161

KIT Salottino in polipropilene con fibra di vetro colore tortora composto da:
2 poltrone, 1 divanetto completi di cuscini e 1 tavolino.

Modern lounge kit in polypropylene with fiber glass taupe color composed of:
2 armchairs, 1 sofa complete with pillows and 1 coffee table.



Divanetto in polipropilene con fibra di vetro e cuscini.
Polypropylene sofa with glass fibre and cushions.
cm. L. 138 P. 72 H. 83 H.S. 46



Poltrona in polipropilene con fibra di vetro e cuscini.
Polypropylene armchair with glass fibre and cushions.
cm. L. 73 P. 72 H. 83 H.S. 46



Tavolino quadrato in polipropilene con fibra di vetro.
Polypropylene square coffee table with glass fibre
cm. L. 65 P. 65 H. 33

COLORI. COLOURS.



Tortora.
Taupe.



Antracite.
Anthracite



Articolo LF6631

KIT Salottino in polipropilene con fibra di vetro color antracite composto da:
2 Poltrone, 1 divanetto completi di cuscini e 1 tavolino con piano vetro.

KIT Sitting area in polypropylene with glass fibre anthracite color consisting of:
2 armchairs, 1 sofa complete with pillows and 1 coffee table with glass top.



Divanetto in polipropilene con fibra di vetro e cuscini.
Polypropylene sofa with glass fibre and cushions.
cm. L. 140 P. 75 H. 78 H.S. 45



Poltrona in polipropilene con fibra di vetro e cuscini.
Polypropylene armchair with glass fibre and cushions.
cm. L. 72 P. 75 H. 78 H.S. 45



Tavolino in polipropilene con fibra di vetro piano in vetro.
Polypropylene coffee table with glass fibre glass top.
cm. L. 67 P. 67 H. 32





Articolo LF6630

KIT Salottino color tortora composto da:

2 Poltrone, 1 divanetto **completi di cuscini** e 1 tavolino con piano vetro.

Modern lounge kit in taupe color consisting of:

2 armchairs, 1 sofa **complete with pillows** and 1 coffee table with glass top.



Divanetto in polipropilene con fibra di vetro e cuscini.

Polypropylene sofa with glass fibre and cushions.

cm. L. 140 P. 75 H. 78 H.S. 45



Poltrona in polipropilene con fibra di vetro e cuscini.

Polypropylene armchair with glass fibre and cushions.

cm. L. 72 P. 75 H. 78 H.S. 45



Tavolino in polipropilene con fibra di vetro piano in vetro.

Polypropylene coffee table with glass fibre glass top.

cm. L. 67 P. 67 H. 32





Articolo LF972

Struttura in alluminio verniciata a polvere antracite
telo copertura poliestere idrorepellente beige.
Anthracite powder coated aluminum structure
beige water-repellent polyester cover.
cm. L. 50 P. 50 H. 250 aperto 300 x 300



Articolo LF973

Struttura in alluminio verniciata a polvere antracite
telo copertura poliestere idrorepellente grigio.
Anthracite powder coated aluminum structure
gray water-repellent polyester cover.
cm. L. 50 P. 50 H. 250 aperto 300 x 300

COPERTURE IDROREPELLENTI O IMPERMEABILI

Uno degli elementi più importanti quando scegliete gli ombrelloni da esterno è il tessuto della copertura.
Il telo dell'ombrellone è fondamentale perché serve a proteggervi dal vento, dal sole e dalla pioggia.
Il fattore da valutare prima di tutti gli altri è soprattutto la resistenza all'acqua.

WATER-REPELLENT OR WATERPROOF COVERS

One of the most important elements when choosing outdoor umbrellas is the cover fabric.
The umbrella cover is essential because it serves to protect you from the wind, sun and rain.
The factor to be evaluated first of all is above all water resistance.

COLORI COPERTURA. COVER COLOURS.



Tessuto Beige.
Beige fabric.



Tessuto grigio.
Gray fabric.



Articolo LF976

Struttura in metallo verniciata a polvere antracite
telo copertura poliestere idrorepellente grigio (senza piastra).
Anthracite powder coated metal structure
gray water-repellent polyester cover (without plate).
cm. L. 50 P. 50 H. 250 aperto 300 x 300



Articolo LF974

Struttura in metallo verniciata a polvere antracite
telo copertura poliestere idrorepellente beige (senza piastra).
Anthracite powder coated metal structure
beige water-repellent polyester cover (without plate).
cm. L. 50 P. 50 H. 250 aperto 300 x 300



Articolo LF6000

Lettino polipropilene con fibra di vetro
colore tortora e tessuto textilene.
Polypropylene cot with glass fiber
taupe color and textilene fabric.
cm. L. 68 P. 193 H. 35



COLORI. COLOURS.



Antracite.
Anthracite.



Tortora.
Taupe.



Articolo LF6001

Lettino polipropilene con fibra di vetro
colore antracite e tessuto textilene.
Polypropylene cot with glass fiber
anthracite color and textilene fabric.
cm. L. 68 P. 193 H. 35



Articolo LF5041

Sdraio piscina fisso color antracite.
Fixed pool deck chair in anthracite color.
cm. L. 70 P. 190 H. 46



Articolo LF5040

Sdraio piscina pieghevole color antracite
impilabile solo da chiuso.
Folding pool deck chair in anthracite color
stackable only when closed.
cm. L. 70 P. 190 H. 46



Articolo LF5021

KIT Salottino intreccio color antracite composto da:

2 Poltrone, **completi di cuscini** e 1 tavolino.

Modern lounge kit anthracite-colored weave consisting of:

2 armchairs, **complete with pillows** and 1 coffee table.



Poltrona in polipropilene con cuscini.

Woven polypropylene armchair with pillows.

cm. L. 60 P. 56 H. 90 H.S. 45



Tavolino in polipropilene intreccio con contenitore.

Woven polypropylene coffee table with inner container.

cm. L. 39 P. 39 H. 46



COLORI. COLOURS.



Antracite.
Anthracite

COLORI. COLOURS.

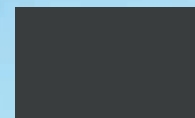

Antracite.
Anthracite



Articolo LF5030

KIT Salottino intreccio color antracite
composto da: 2 Poltrone, 1 divanetto completi
di cuscini e 1 tavolino.

Modern lounge KIT anthracite colored weave
consisting of: 2 armchairs, 1 sofa complete
with pillows and 1 coffee table.

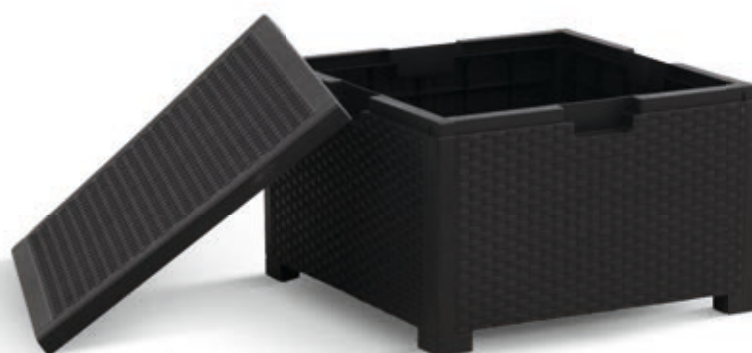

Divanetto in polipropilene intreccio.
Woven polypropylene small sofa.
cm. L. 131 P. 58 H. 79 H.S. 40



Poltrona in polipropilene intreccio.
Woven polypropylene armchair.
cm. L. 75 P. 58 H. 79 H.S. 40



Tavolino in polipropilene intreccio.
Woven polypropylene coffee table.
cm. L. 94 P. 64 H. 40

ATHENA INDICE





UN'ABITAZIONE RICAVATA DA UN AMBIENTE UNICO, Scopri sedie, poltrone, tavoli e complementi di design che si combinano con i mobili della tua sala da pranzo, soggiorno, cucina o terrazza. Trova l'opzione migliore per le tue stanze, scopri materiali, stili e colori esclusivi per differenziare la tua casa, trasformala in uno spazio comodo e piacevole per te e i tuoi ospiti. Sedie, tavoli e complementi di design ideale per la tua casa o il tuo spazio di lavoro, che si tratti di sedie in legno, sedie in plastica, metallo o sedie moderne a seconda del colore, come sedie gialle, sedie trasparenti, sedie nere, tra molte altre. Abbiamo anche sedie, poltrone, tavoli e complementi a seconda dello spazio in cui verranno collocate, dalle sedie da pranzo alle sedie da giardino. La nostra collezione offre una vasta gamma di mobili per soddisfare sia le impostazioni casual che quelle formali per la tua casa o lo spazio di lavoro.



A HOUSE OBTAINED FROM A UNIQUE ENVIRONMENT, Discover chairs, armchairs, tables and design accessories that combine with the furniture in your dining room, living room, kitchen or terrace. Find the best option for your rooms, discover exclusive materials, styles and colors to differentiate your home, transform it into a comfortable and pleasant space for you and your guests. Chairs, tables and design accessories ideal for your home or workspace, whether it's wooden chairs, plastic chairs, metal or modern chairs depending on the color, such as yellow chairs, transparent chairs, black chairs, among many others. We also have chairs, armchairs, tables and accessories depending on the space in which they will be placed, from dining chairs to garden chairs. Our collection offers a wide variety of furniture to suit both casual and formal settings for your home or workspace.



ATHENA dea dai mille volti... dea delle arti e dei mestieri, della battaglia e della strategia, nonché della sapienza.
Goddess ATHENA of a thousand faces... goddess of arts and crafts, of battle and strategy, as well as of wisdom

300/GL Pag. 106	
301/GL Pag. 106	
302/GL Pag. 106	
310 GBI CREMA Pag. 76	
310 GBI GIALLO Pag. 76	
310 GBI LILLA Pag. 76	
310 GBI LIME Pag. 76	
310 GBLE Pag. 74	
310 GBPE Pag. 74	

310 GLLE Pag. 74	
310 GLPE Pag. 74	
310 GP BIANCO Pag. 75	
310 GP BLU Pag. 75	
310 GP GIALLO Pag. 75	
310 GP TRASPARENTE Pag. 75	
310 GP NERO Pag. 75	
310 GP ROSSO Pag. 75	
310 GP VERDE Pag. 75	
310 GSL BIANCO Pag. 74	











310 GSL GRIGIO Pag. 74	
325 GBI ARANCIONE Pag. 76	
325 GBI AZZURRO Pag. 76	
325 GBI CREMA Pag. 76	
325 GBI GIALLO Pag. 76	
325 GBI GRIGIO Pag. 76	
325 GBI LILLA Pag. 76	
325 GBI LIME Pag. 76	
325 GBLE Pag. 77	
325 GBPE Pag. 77	







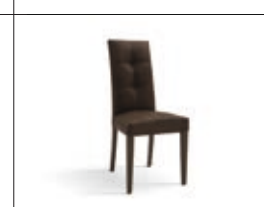

































325 GLLE Pag. 77	
325 GLPE Pag. 77	
326 GL BIANCO Pag. 72	
326 GL GRIGIO Pag. 72	
326 GSL BIANCO Pag. 73	
326 GSL GRIGIO Pag. 73	
381 GBLE Pag. 77	
381 GBPE Pag. 77	
381 GLLE Pag. 77	
381 GLPE Pag. 77	











LF110 BIANCO Pag. 107	
LF206Z Pag. 67	
LF207Z Pag. 67	
LF208Z Pag. 67	
LF209Z Pag. 67	
LF210 NOCE INVECCHIATO Pag. 88	
LF211 NOCE INVECCHIATO Pag. 88	
LF213 NOCE INVECCHIATO Pag. 88	
LF215 Pag. 88	
LF217 Pag. 88	

LF218 Pag. 88	
LF235 GL BIANCO Pag. 78	
LF235 GL GRIGIO Pag. 78	
LF235 GV BIANCO Pag. 78	
LF235 GV GRIGIO Pag. 78	
LF242 GBL Pag. 78	
LF243 Pag. 62	
LF244 Pag. 62	
LF247 Pag. 62	
LF248 Pag. 62	





LF249 Pag. 60	
LF250 Pag. 60	
LF251 Pag. 62	
LF254 Pag. 61	
LF256 Pag. 61	
LF258 Pag. 61	
LF259 Pag. 61	
LF261 Pag. 63	
LF264 Pag. 63	
LF265 Pag. 61	











LF266 Pag. 63	
LF267 Pag. 60	
LF268 Pag. 60	
LF269 Pag. 61	
LF280 Pag. 65	
LF281 Pag. 65	
LF282 Pag. 65	
LF285 Pag. 64	
LF286 Pag. 64	
LF287 Pag. 64	







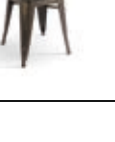

































LF290 Pag. 56		LF372 Pag. 27		LF390 Pag. 30		LF404 MIELE Pag. 147	
LF291 Pag. 56		LF373 Pag. 27		LF391 Pag. 30		LF405 BIANCO Pag. 148	
LF292 Pag. 56		LF381 Pag. 26		LF392 Pag. 30		LF405 CENERE Pag. 148	
LF306 GL NAT Pag. 146		LF382 Pag. 26		LF393 Pag. 30		LF405 MIELE Pag. 148	
LF311 GL NAT Pag. 146		LF383 Pag. 26		LF400 CENERE Pag. 146		LF432 Pag. 66	
LF360 Pag. 18		LF384 Pag. 26		LF400 MIELE Pag. 146		LF432 C Pag. 66	
LF361 Pag. 18		LF385 Pag. 18		LF401 BIANCO Pag. 147		LF441 Pag. 33	
LF362 Pag. 18		LF386 Pag. 18		LF401 CENERE Pag. 147		LF443 Pag. 68	
LF370 Pag. 27		LF387 Pag. 18		LF404 BIANCO Pag. 147		LF446 Pag. 69	
LF371 Pag. 27		LF388 Pag. 18		LF404 CENERE Pag. 147		LF456 Pag. 33	

LF457 Pag. 33	
LF458 Pag. 33	
LF459 Pag. 33	
LF460 Pag. 33	
LF461 Pag. 33	
LF477 Pag. 66	
LF479 Pag. 66	
LF482 Pag. 32	
LF483 Pag. 32	
LF484 Pag. 32	

LF493 Pag. 130	
LF496 Pag. 66	
LF498 Pag. 53	
LF499 Pag. 53	
LF502 Pag. 25	
LF503 Pag. 25	
LF509 Pag. 25	
LF516 Pag. 39	
LF517 Pag. 39	
LF540 Pag. 67	









LF542 Pag. 53	
LF544 Pag. 53	
LF548 Pag. 53-70	
LF556 Pag. 91	
LF557 Pag. 92	
LF559 Pag. 91	
LF561 Pag. 84	
LF564 Pag. 90	
LF566 Pag. 90	
LF567 Pag. 90	











LF568 Pag. 91	
LF569 Pag. 90	
LF571 Pag. 90	
LF572 Pag. 90	
LF573 Pag. 90	
LF574 Pag. 90	
LF576 Pag. 25	
LF577 Pag. 25	
LF580 Pag. 92	
LF581 Pag. 91	









































LF582 Pag. 91		LF612 Pag. 108		LF639 Pag. 42		LF673 Pag. 42	
LF587 Pag. 91		LF614 Pag. 108		LF642 Pag. 38		LF679 Pag. 69	
LF590 Pag. 31		LF625 Pag. 39		LF651 Pag. 67		LF681 Pag. 92	
LF591 Pag. 31		LF626 Pag. 39		LF656 Pag. 68		LF682 Pag. 92	
LF592 Pag. 31		LF627 Pag. 39		LF660 Pag. 68		LF684 Pag. 68	
LF600 Pag. 107		LF628 Pag. 39		LF661 Pag. 69		LF685 Pag. 69	
LF603 Pag. 107		LF630 Pag. 26		LF662 Pag. 69		LF686 Pag. 26	
LF605 Pag. 108		LF631 Pag. 26		LF663 Pag. 68		LF687 Pag. 92	
LF607 Pag. 108		LF632 Pag. 26		LF665 Pag. 68		LF688 Pag. 92	
LF610 Pag. 108		LF634 Pag. 26		LF666 Pag. 69		LF699 Pag. 67	

LF700 Pag. 128	
LF701 Pag. 128	
LF705 Pag. 127	
LF712 Pag. 127	
LF713 Pag. 129	
LF716 Pag. 127	
LF717 Pag. 129	
LF718 Pag. 29	
LF719 Pag. 29	
LF720 Pag. 127	











LF721 Pag. 129	
LF729 Pag. 29	
LF731 Pag. 129	
LF743 Pag. 130	
LF745 Pag. 105	
LF763 Pag. 137	
LF764 Pag. 137	
LF769 Pag. 28	
LF770 Pag. 42	
LF773 Pag. 28	

LF774 Pag. 28	
LF779 Pag. 37	
LF781 Pag. 37	
LF782 Pag. 37	
LF787 Pag. 36	
LF789 Pag. 19	
LF790 Pag. 19	
LF791 Pag. 36	
LF795 Pag. 19	
LF796 Pag. 37	

LF797 Pag. 37	
LF803 Pag. 114	
LF804 Pag. 114	
LF806 Pag. 111	
LF806 ALTO Pag. 110	
LF807 Pag. 110	
LF808 Pag. 110	
LF809 Pag. 111	
LF812 Pag. 114	
LF813 Pag. 114	









































LF815 Pag. 111		LF832 Pag. 115		LF845 Pag. 116		LF866 Pag. 141	
LF816 Pag. 111		LF834 Pag. 138		LF846 Pag. 116		LF867 Pag. 141	
LF818 Pag. 111		LF835 Pag. 138		LF849 Pag. 89		LF868 Pag. 141	
LF818 ESTERNO Pag. 111		LF836 Pag. 138		LF850 Pag. 119		LF869 Pag. 141	
LF821 Pag. 114		LF837 Pag. 138		LF853 Pag. 89		LF873 Pag. 142	
LF827 Pag. 113-120		LF838 Pag. 138		LF855 Pag. 119		LF874 Pag. 143	
LF828 Pag. 113-120		LF839 Pag. 138		LF858 Pag. 141		LF875 Pag. 142	
LF829 Pag. 115		LF840 Pag. 116-117		LF859 Pag. 140		LF876 Pag. 143	
LF830 Pag. 115		LF842 Pag. 116-117		LF860 Pag. 119		LF877 Pag. 143	
LF831 Pag. 115		LF843 Pag. 89		LF865 Pag. 141		LF879 Pag. 142	

LF881 Pag. 142	
LF885 Pag. 140	
LF886 Pag. 140	
LF887 Pag. 140	
LF888 Pag. 140	
LF890 Pag. 29	
LF896 Pag. 73	
LF899 Pag. 43	
LF925 Pag. 31	
LF926 Pag. 31	



LF928 Pag. 31	
LF931 Pag. 86	
LF934 Pag. 86	
LF935 Pag. 86	
LF936 Pag. 73	
LF937 Pag. 73	
LF938 Pag. 43	
LF939 Pag. 86	
LF940 Pag. 86	
LF941 Pag. 43	

LF942 Pag. 43	
LF949 Pag. 43	
LF952 Pag. 29	
LF960 Pag. 84	
LF961 Pag. 84	
LF963 Pag. 84	
LF964 Pag. 84	
LF966 Pag. 87	
LF967 Pag. 87	
LF968 Pag. 87	









LF969 Pag. 87	
LF972 Pag. 158	
LF973 Pag. 158	
LF974 Pag. 159	
LF976 Pag. 159	
LF982 Pag. 87	
LF984 Pag. 87	
LF986 Pag. 84	

























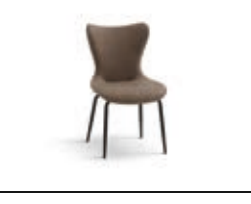





LF990 Pag. 104		LF1029 Pag. 144		LF1500 Pag. 116		LF1600 Pag. 132	
LF991 Pag. 104		LF1046 Pag. 145		LF1501 Pag. 116		LF1605 Pag. 133	
LF992 Pag. 55		LF1047 Pag. 145		LF1502 Pag. 116		LF1606 Pag. 133	
LF993 Pag. 55		LF1110 Pag. 118		LF1510 Pag. 116		LF1607 Pag. 132	
LF994 Pag. 55		LF1111 Pag. 118		LF1511 Pag. 116		LF1608 Pag. 133	
LF995 Pag. 55		LF1120 Pag. 118		LF1550 Pag. 116-117		LF1609 Pag. 133	
LF996 Pag. 55		LF1130 Pag. 118		LF1551 Pag. 116-117		LF1610 Pag. 133	
LF1004 Pag. 145		LF1131 Pag. 118		LF1552 Pag. 116-117		LF1620 Pag. 132	
LF1005 Pag. 145		LF1140 Pag. 118		LF1560 Pag. 116-117		LF1621 Pag. 132	
LF1028 Pag. 144		LF1150 Pag. 118		LF1561 Pag. 116-117		LF1622 Pag. 132	

LF1623 Pag. 134	
LF1624 Pag. 134	
LF1625 Pag. 134	
LF1626 Pag. 134	
LF1627 Pag. 134	
LF1628 Pag. 135	
LF1629 Pag. 135	
LF1630 Pag. 135	
LF1631 Pag. 134	
LF1650 Pag. 139	

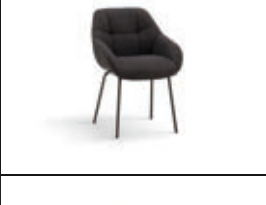
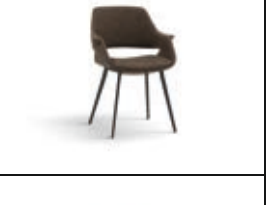
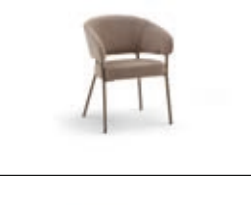
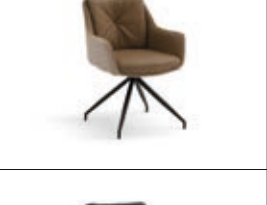
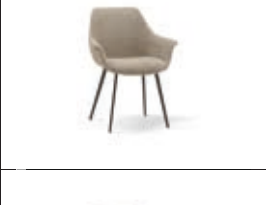
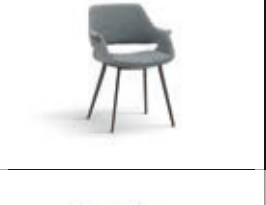
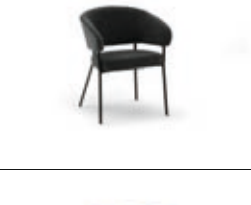
LF1651 Pag. 139	
LF1700 Pag. 101	
LF1701 Pag. 101	
LF1705 Pag. 101	
LF1706 Pag. 101	
LF2000 Pag. 122	
LF2001 Pag. 122	
LF2002 Pag. 122	
LF2010 Pag. 123	
LF2011 Pag. 123	

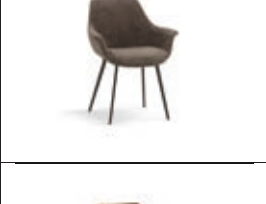
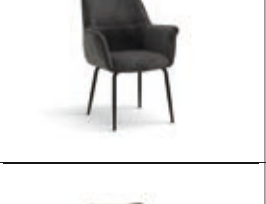
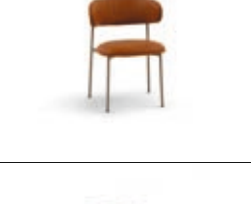
LF2012 Pag. 123	
LF2020 Pag. 124	
LF2021 Pag. 124	
LF2025 Pag. 124	
LF2026 Pag. 124	
LF2030 Pag. 125	
LF2031 Pag. 125	
LF2040 Pag. 126	
LF2041 Pag. 126	
LF2042 Pag. 126	

LF2043 Pag. 126	
LF2050 Pag. 125	
LF2051 Pag. 125	
LF2055 Pag. 123	
LF2056 Pag. 123	
LF2100 Pag. 54	
LF2101 Pag. 54	
LF2102 Pag. 54	
LF2103 Pag. 54	
LF2110 Pag. 47	







































LF2111 Pag. 47		LF2141 Pag. 50		LF2176 Pag. 49		LF2205 Pag. 57	
LF2115 Pag. 47		LF2150 Pag. 51		LF2180 Pag. 48		LF2206 Pag. 57	
LF2116 Pag. 47		LF2151 Pag. 51		LF2181 Pag. 48		LF2210 Pag. 58	
LF2120 Pag. 47		LF2155 Pag. 51		LF2182 Pag. 48		LF2211 Pag. 58	
LF2121 Pag. 47		LF2156 Pag. 51		LF2190 Pag. 46		LF2215 Pag. 57	
LF2125 Pag. 47		LF2160 Pag. 52		LF2191 Pag. 46		LF2216 Pag. 57	
LF2126 Pag. 47		LF2161 Pag. 52		LF2195 Pag. 46		LF2220 Pag. 59	
LF2130 Pag. 50		LF2170 Pag. 49		LF2196 Pag. 46		LF2221 Pag. 59	
LF2131 Pag. 50		LF2171 Pag. 49		LF2200 Pag. 52-70		LF2225 Pag. 59	
LF2140 Pag. 50		LF2175 Pag. 49		LF2201 Pag. 52		LF2226 Pag. 59	

LF2300 Pag. 80	
LF2301 Pag. 80	
LF2305 Pag. 81	
LF2306 Pag. 81	
LF2310 Pag. 83	
LF2311 Pag. 83	
LF2315 Pag. 80	
LF2316 Pag. 80	
LF2320 Pag. 82	
LF2321 Pag. 82	

LF2325 Pag. 82	
LF2326 Pag. 82	
LF5000 Pag. 44	
LF5001 Pag. 44	
LF5010 Pag. 105	
LF5011 Pag. 105	
LF5021 Pag. 161	
LF5030 Pag. 162	
LF5040 Pag. 160	

LF5041 Pag. 160	
LF6000 Pag. 160	
LF6001 Pag. 160	
LF6005 Pag. 44	
LF6006 Pag. 44	
LF6010 Pag. 15	
LF6011 Pag. 15	
LF6012 Pag. 15	
LF6013 Pag. 15	
LF6020 Pag. 14	

LF6021 Pag. 14	
LF6022 Pag. 14	
LF6023 Pag. 14	
LF6030 Pag. 17	
LF6031 Pag. 17	
LF6040 Pag. 17	
LF6041 Pag. 17	
LF6050 Pag. 20	
LF6051 Pag. 20	
LF6052 Pag. 20	

LF6053 Pag. 20		LF6080 Pag. 08		LF6110 Pag. 152		LF6136 Pag. 41	
LF6055 Pag. 05		LF6081 Pag. 08		LF6111 Pag. 152		LF6140 Pag. 10	
LF6056 Pag. 05		LF6083 Pag. 09		LF6112 Pag. 152		LF6141 Pag. 10	
LF6057 Pag. 05		LF6084 Pag. 09		LF6120 Pag. 40		LF6145 Pag. 10	
LF6060 Pag. 13		LF6085 Pag. 09		LF6121 Pag. 40		LF6146 Pag. 10	
LF6061 Pag. 13		LF6086 Pag. 09		LF6125 Pag. 41		LF6150 Pag. 12	
LF6062 Pag. 13		LF6087 Pag. 09		LF6126 Pag. 41		LF6155 Pag. 12	
LF6063 Pag. 13		LF6088 Pag. 09		LF6130 Pag. 41		LF6160  Pag. 154	
LF6070 Pag. 38		LF6090 Pag. 19		LF6131 Pag. 41		LF6161  Pag. 155	
LF6075 Pag. 42		LF6091 Pag. 19		LF6135 Pag. 41			

LF6165 Pag. 11	
LF6166 Pag. 11	
LF6167 Pag. 11	
LF6170 Pag. 150	
LF6171 Pag. 150	
LF6172 Pag. 150	
LF6173 Pag. 150	
LF6174 Pag. 07	
LF6175 Pag. 07	
LF6176 Pag. 07	

LF6177 Pag. 07	
LF6178 Pag. 06	
LF6179 Pag. 06	
LF6180 Pag. 06	
LF6181 Pag. 06	
LF6183 Pag. 07	
LF6184 Pag. 07	
LF6185 Pag. 07	
LF6186 Pag. 06	
LF6190 Pag. 16	



LF6191 Pag. 16	
LF6195 Pag. 16	
LF6196 Pag. 16	
LF6200 Pag. 97	
LF6201 Pag. 97	
LF6210 Pag. 97	
LF6211 Pag. 97	
LF6220 Pag. 97	
LF6221 Pag. 97	
LF6230 Pag. 113	

LF6231 Pag. 113	
LF6240 Pag. 98	
LF6241 Pag. 98	
LF6245 Pag. 98	
LF6246 Pag. 99	
LF6251 Pag. 99	
LF6260 Pag. 136	
LF6261 Pag. 136	
LF6262 Pag. 136	
LF6265 Pag. 137	

LF6266 Pag. 137		LF6521 Pag. 85		LF6566 Pag. 112		LF6620 Pag. 42	
LF6267 Pag. 137		LF6525 Pag. 85		LF6600 Pag. 24		LF6621 Pag. 22	
LF6270 Pag. 94		LF6530 Pag. 85		LF6601 Pag. 24		LF6622 Pag. 22	
LF6271 Pag. 94		LF6550 Pag. 100		LF6605 Pag. 24		LF6623 Pag. 22	
LF6272 Pag. 94		LF6551 Pag. 100		LF6606 Pag. 24		LF6625 Pag. 23	
LF6275 Pag. 95		LF6555 Pag. 100		LF6610 Pag. 21		LF6626 Pag. 23	
LF6276 Pag. 95		LF6556 Pag. 100		LF6611 Pag. 21		LF6627 Pag. 23	
LF6277 Pag. 95		LF6560 Pag. 112		LF6612 Pag. 21		LF6630 Pag. 156-157	
LF6510 Pag. 152		LF6561 Pag. 112		LF6613 Pag. 21		LF6631 Pag. 156-157	
LF6520 Pag. 85		LF6565 Pag. 112		LF6615 Pag. 42			

LF7000 Pag. 34	
LF7001 Pag. 34	
LF7002 Pag. 34	
LF7003 Pag. 34	
LF7010 Pag. 35	
LF7011 Pag. 35	
LF7012 Pag. 35	
LF7013 Pag. 35	
LF8014 ANTRACITE Pag. 104	
LF8014 FANGO Pag. 104	

LF8021 ANTRACITE Pag. 103	
LF8021 BIANCO Pag. 103	
LF8021 FANGO Pag. 103	
LF8022 ANTRACITE Pag. 102	
LF8022 BIANCO Pag. 102	
LF8022 FANGO Pag. 102	
LF8025 ANTRACITE Pag. 103	
LF8025 BIANCO Pag. 103	
LF8025 FANGO Pag. 103	
LF8026 ANTRACITE Pag. 104	

LF8026 BIANCO Pag. 104	
LF8026 FANGO Pag. 104	

ATHENA

ATHENAHOME&CONTRACT

ATTENZIONE Gli articoli inseriti nella presente brochure provengono da diverse ditte fornitrici e sono stati selezionati per il loro specifico rapporto prezzo/qualità. L'approvvigionamento viene effettuato a lotti, pertanto può succedere che alcuni articoli possono presentare a seconda del lotto di provenienza, sfumature, finiture o tonalità cromatiche diverse rispetto alla foto o al lotto precedente; pertanto, questa eventuale difformità, non potrà mai essere pretesto per contestare o richiedere la sostituzione del prodotto già fornito. Così come, nonostante l'attenzione e la cura prestata nella selezione del prodotto, eventuali piccole imperfezioni sono da considerare tipiche della gamma in un contesto Low Cast.

ATTENTION The items included in this brochure come from various supplier companies and have been selected for their specific price/quality ratio. Procurement is carried out in batches, therefore it may happen that some items may present different shades, finishes or chromatic tones depending on the batch of origin, compared to the photo or the previous batch; therefore, this possible discrepancy can never be a pretext for contesting or requesting the replacement of the product already supplied. Just as, despite the attention and care paid in the selection of the product, any small imperfections are to be considered typical of the range in a Low Cast context.



Sede operativa:
Cascina Rubina, 34bis 10046
POIRINO (TO)
Tel. 0119453624
Fax 0119453784
Daniela: 3355292443 Donato:
3491718792 Gabriele:
3491875511
themasedietavoli@gmail.com
www.themasas.com